

PRODUCT LCD MODULE
产品名称 : 液晶显示模块

MODEL NO.
模块型号 : TFT480854-2-E

SUPPLIER TRULY SEMICONDUCTORS LTD.
供应商 : 信利半导体有限公司

DATE 日期 : April 9, 2012



CERT. No. QAC0946535
(ISO9001)



CERT. No. HKG002005
(ISO14001)

SPECIFICATION

产品说明书

Revision: 1.0

版本: 1.0

TFT480854-2-E

This module uses ROHS material
 模块用环保材料

This specification may change without prior notice in order to improve performance or quality. Please contact TRULY R&D department for updated specification and product status before design for this product or release of this order.

为了提高产品性能和质量, 此规格书及其内容均有可能在没有预先通告的情况下做出修改, 请在产品设计或下单之前联系信利研发部门索要最新规格书。

TRULY SEMICONDUCTORS LTD:

信利半导体有限公司

Quality Assurance Department: _____

质量保证部门

Approved by: _____

核准

Technical Department: _____

技术部门

CUSTOMER:

客户:

Approved by:

核准:

CONTENTS 内容**■ GENERAL INFORMATION**

主要特征描述

■ EXTERNAL DIMENSIONS

外形尺寸

■ ABSOLUTE MAXIMUM RATINGS

极限参数

■ ELECTRICAL CHARACTERISTICS

模块电气特性

■ BACKLIGHT CHARACTERISTICS

背光电气特性

■ ELECTRO-OPTICAL CHARACTERISTICS

光电参数

■ INTERFACE DESCRIPTION

接口定义描述

■ REFERENCE APPLICATION CIRCUIT

参考应用电路

■ RELIABILITY TEST CONDITIONS

可靠性试验条件

■ INSPECTION CRITERION

检查标准

■ PRECAUTIONS FOR USING LCD MODULES

使用注意事项

■ PACKING SPECIFICATION

包装规格书

■ PRIOR CONSULT MATTER

提前商议事项

■ FACTORY CONTACT INFORMATION

工厂联系信息

WRITTEN BY 制作	CHECKED BY 检查	APPROVED BY 核准
HUANG YAN XUE	WANG JI YONG	ZHANG SHU HANG

■ GENERAL INFORMATION**主要特征描述**

Item of general information 项目	Contents 内容	Unit 单位
LCD Type 液晶显示类型	TFT/TRANSMISSIVE	/
Recommended Viewing Direction 模块推荐使用方向	Wide View Angle	O' Clock
Module area (W × H×T) 模块外围尺寸 (宽 × 高×厚)	63.40×113.58×2.45	mm ³
Viewing area (W×H) 可视区域 (宽 × 高)	59.20×104.08	mm ²
Active area (W×H) 有效区域 (宽 × 高)	57.60×102.48	mm ²
Number of Dots 点阵	480RGB×854	/
Pixel pitch (W × H) 像素间隙(宽 × 高)	0.135×0.135	mm ²
Driver IC 驱动集成电路	HX8363-B	/
Interface Type 接口类型	MPU/SPI+RGB/MIPI/MDDI	/
Input voltage 输入电压	3.3	V
Module Power consumption 模块功耗	805	mw
Colors 色彩	16.7M	/
Backlight Type 背光类型	LED	/
Weight 重量	29.9	g

EXTERNAL DIMENSIONS
外形尺寸

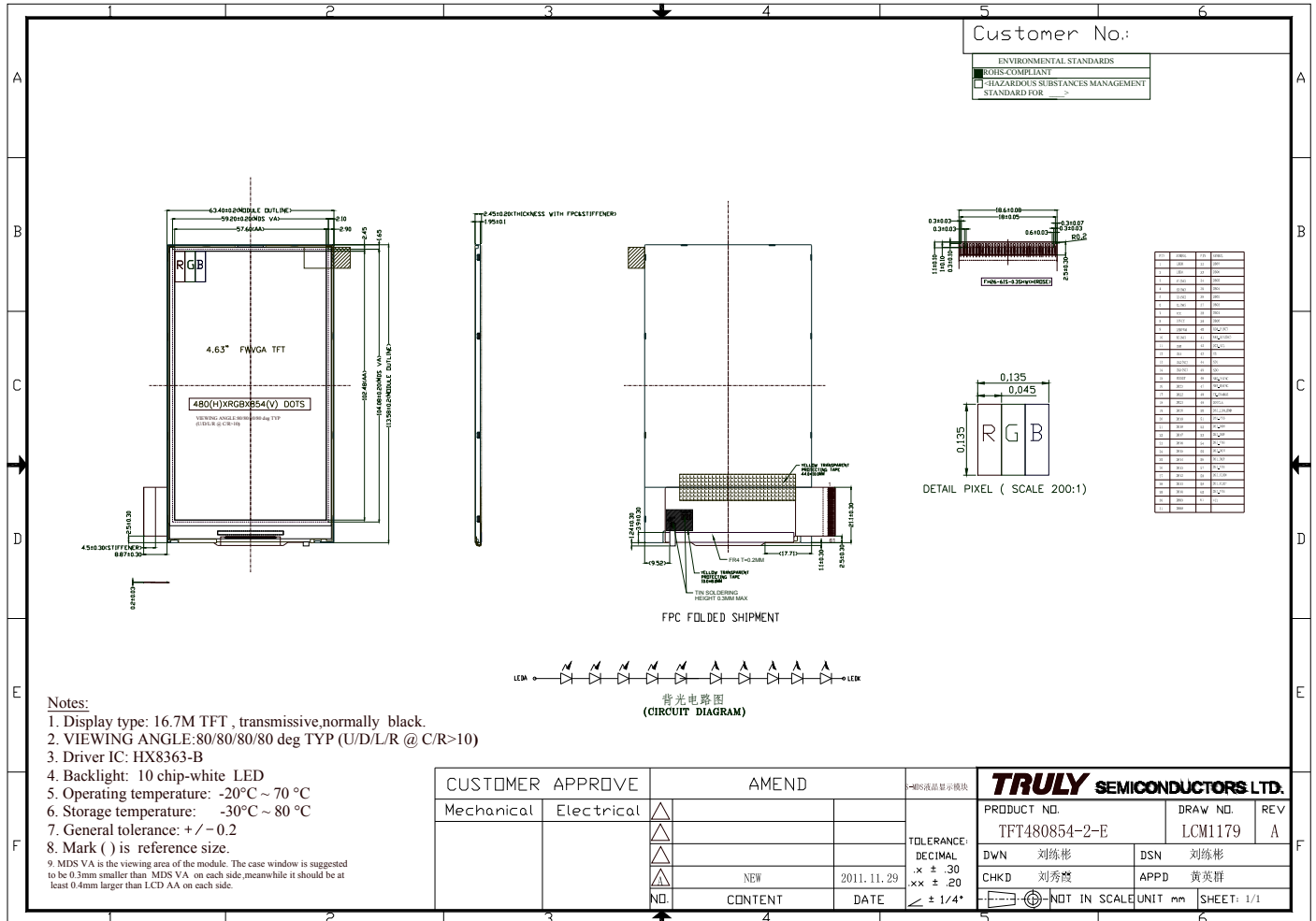

■ ABSOLUTE MAXIMUM RATINGS

极限参数

Parameter of absolute maximum ratings 参数	Symbol 符号	Min 最小值	Max 最大值	Unit 单位
Supply voltage for logic 逻辑电压	VCC/VCI	-0.3	5.5	V
Input voltage 输入电压	VIN	-0.3	IOVCC+0.3	V
Operating temperature 操作温度	Top	-20	70	°C
Storage temperature 储存温度	TST	-30	80	°C
Humidity 湿度	RH	-	90%(Max60 °C)	RH
Supply voltage for I/O	IOVCC	-0.3	3.6	V

■ ELECTRICAL CHARACTERISTICS

模块电气特性

DC CHARACTERISTICS

直流特性

Parameter of DC characteristics 参数	Symbol 符号	Min 最小值	Typ 典型值	Max 最大值	Unit 单位
Supply voltage for logic 逻辑电压	VCC/VCI	2.3	2.8/3.3	4.8	V
I/O power supply 接口电压	IOVCC	1.65	2.8/3.3	3.3	V
Input Current 输入电流	I _{dd}	-	42	50	mA
Input voltage 'H' level 输入高电平	V _{IH}	0.7IOVCC	-	IOVCC	V
Input voltage 'L' level 输入低电平	V _{IL}	0	-	0.3IOVCC	V
Output voltage 'H' level 输出高电平	V _{OH}	0.8IOVCC	-	IOVCC	V
Output voltage 'L' level 输出低电平	V _{OL}	0	-	0.2IOVCC	V

■ BACKLIGHT CHARACTERISTICS

背光电气特性

Item of backlight characteristics 项目	Symbol	Min.	Typ.	Max.	Unit	Condition
Forward voltage 正向电压	V _f	29	32	34	V	I _f =20mA
Number of LED 灯数	-	-	10	-	Piece	-
Connection mode 连接类型	S	-	Serial	-	-	-

Using condition: constant current driving method I_f=20mA(+/-10%).

使用条件: 恒流的驱动方式是 I_f=20mA(+/-10%).

■ ELECTRO-OPTICAL CHARACTERISTICS

光电参数

Item of electro-optical characteristics 项目	Symbol 符号	Condition 条件	Min 最小值	Typ 典型值	Max 最大值	Unit 单位	Remark 注释	Note 备注
Response time 响应时间	Tr+ Tf	θ=0° ∅=0° Ta=25°C	-	45	70	ms	Fig.1	4
Contrast ratio 对比度	Cr		300	650	-	---	FIG 2.	1
Luminance uniformity 均匀度	δ WHITE		80	-	-	%	FIG 3.	3
Surface Luminance 表面亮度	Lv		340	430	-	cd/m ²	FIG 3.	2
Viewing angle range 视角范围	θ	∅ = 90°	80	-	-	deg	FIG 4.	6
		∅ = 270°	80	-	-	deg	FIG 4	
		∅ = 0°	80	-	-	deg	FIG 4	
		∅ = 180°	80	-	-	deg	FIG4.	
NTSC ratio 色彩饱和度	---	---	-	61	-	%	-	-
CIE (x, y) chromaticity	Red x	θ=0° ∅=0° Ta=25°C	0.5789	0.6289	0.6789	-	FIG 3.	5
	Red y		0.2995	0.3495	0.3995	-		
	Green x		0.2911	0.3411	0.3911	-		
	Green y		0.5462	0.5962	0.6462	-		
	Blue x		0.1031	0.1531	0.2031	-		
	Blue y		0.0311	0.0811	0.1311	-		
	White x		0.2505	0.3105	0.3705	-		
	White y		0.2634	0.3234	0.3834	-		

Note1. Contrast Ratio(CR) is defined mathematically by the following formula. For more information see FIG 2.:

$$\text{ContrastRatio} = \frac{\text{AverageSurface Luminance with all white pixels (P 1,P2, P 3,P4, P5)}}{\text{Average SurfaceLuminance with all black pixels (P1, P2, P 3,P4, P5)}}$$

备注1. 对比度是由以下公式计算所得。详见FIG 2.。

对比度= 显示白色画面时平均表面亮度(P 1,P2, P 3,P4, P5) / 显示黑色画面时平均表面亮度(P 1,P2, P 3,P4, P5)

Note2. Surface luminance is the LCD surface from the surface with all pixels displaying white. For more information see FIG 3.

Lv = Average Surface Luminance with all white pixels (P1, P2, P 3,P4, P5,P6,P7,P8,P9)

备注2. 表面亮度是在显示白色画面时，测试的亮度值，详见FIG 3.。

Lv =平均的表面亮度 (P1, P2, P 3,P4, P5,P6,P7,P8,P9)

Note3. The uniformity in surface luminance (δ WHITE) is determined by measuring luminance at each test position 1 through 9, and then dividing the maximum luminance of 9 points luminance by minimum luminance of 9 points luminance. For more information see FIG 3.

$$\delta \text{ WHITE} = \frac{\text{Minimum Surface Luminance with all white pixels (P1, P2, P3, P4, P5, P6, P7, P8, P9)}}{\text{Maximum Surface Luminance with all white pixels (P1, P2, P3, P4, P5, P6, P7, P8, P9)}}$$

备注3. 均匀度是在显示白色画面时，测试P1到P9的亮度，然后再用9个点亮度的最小值除以最大值。详见FIG 3.。

$$\text{均匀度} = \frac{\text{表面亮度最小值 (P1, P2, P3, P4, P5, P6, P7, P8, P9)}}{\text{表面亮度最大值 (P1, P2, P3, P4, P5, P6, P7, P8, P9)}}$$

Note4. Response time is the time required for the display to transition from White to black(Rise Time, Tr) and from black to white(Decay Time, Tf). For additional information see FIG 1..

备注4. 响应时间是 Tr (上升时间)与Tf(下降时间)的和; Tr 指显示黑色画面转为显示白色画面需要时间, Tf 指显示白色画面转为显示黑色画面需要时间。详见FIG 1.。

Note5. CIE (x, y) chromaticity , The x,y value is determined by average of (P1, P2, P3, P4, P5, P6, P7, P8, P9) . For more information see FIG 3.

备注5. CIE(x,y)色坐标 x,y坐标是 (P1, P2, P3, P4, P5, P6, P7, P8, P9)的平均值。详见FIG 3.。

Note6. Viewing angle is the angle at which the contrast ratio is greater than a specific value. For TFT module, the specific value of contrast ratio is 10; For monochrome and color stn module, the specific value of contrast ratio is 2. The angles are determined for the horizontal or x axis and the vertical or y axis with respect to the z axis which is normal to the LCD surface. For more information see FIG 4.

备注6. 视角 指对比度大于等于一个特定值时的可视范围，对TFT屏，对比度特定值为10，对黑白屏，CSTN屏，对比度特定值为2。视角由横轴（x轴），竖轴（y轴）同Z轴（垂直于LCD表面）之间的夹角来定义。详见FIG 4.。

Note7. For Viewing angle and response time testing, the testing data is base on Autronic-Melchers's ConoScope. Series Instruments. For contrast ratio, Surface Luminance, Luminance uniformity and CIE, the testing data is base on CS-2000 photo detector.

备注7. 视角和响应时间，测试数据基于Autronic-Melchers's ConoScope.系列。而对比度，表面亮度，均匀度，CIE坐标，测试数据基于CS-2000 photo detector。

Note8. For TN type TFT transmissive module, Gray scale reverse occurs in the direction of panel viewing angle

备注8. TN型TFT全透产品,在视角方向会发生灰度反转。

FIG.1. The definition of Response Time
响应时间定义

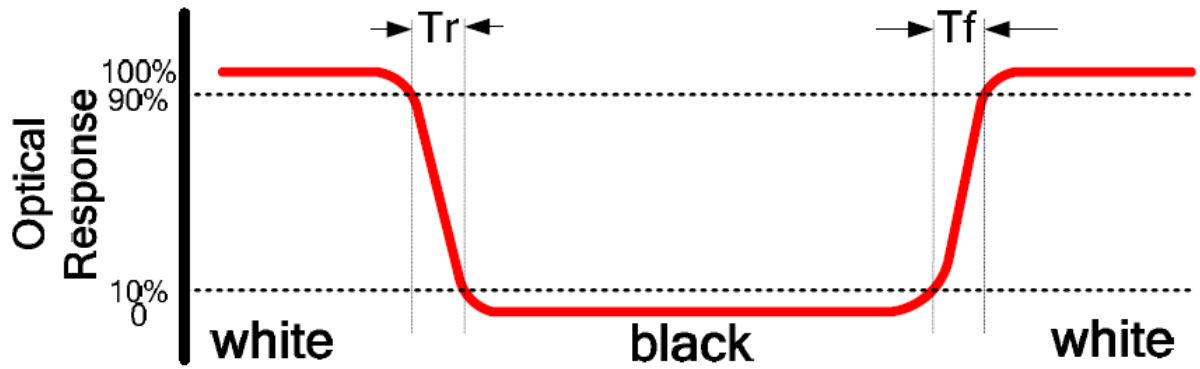

FIG.2. Measuring method for Contrast ratio
对比度 测试方法

A : 5 mm
 B : 5 mm
 H, V : Active Area
 Light spot size $\varnothing=5\text{mm}$, 350mm distance from the LCD surface to detector lens
 measurement instrument is CS-2000

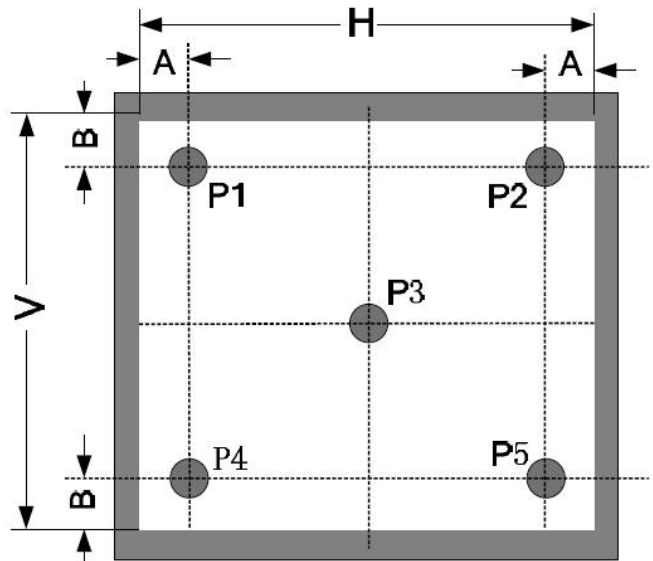

FIG.3. Measuring method for surface luminance, Luminance uniformity, CIE (x, y) chromaticity

表面亮度，均匀度，CIE坐标测试方法

A : H/6 (if Active Area size < 4.0inch);
 H/10 (if Active Area size ≥ 4.0inch)
 B : H/6 (if Active Area size < 4.0inch);
 H/10 (if Active Area size ≥ 4.0inch)
 H, V : Active Area
 Light spot size $\varnothing=5\text{mm}$, 350mm distance from the LCD surface to detector lens
 measurement instrument is CS-2000

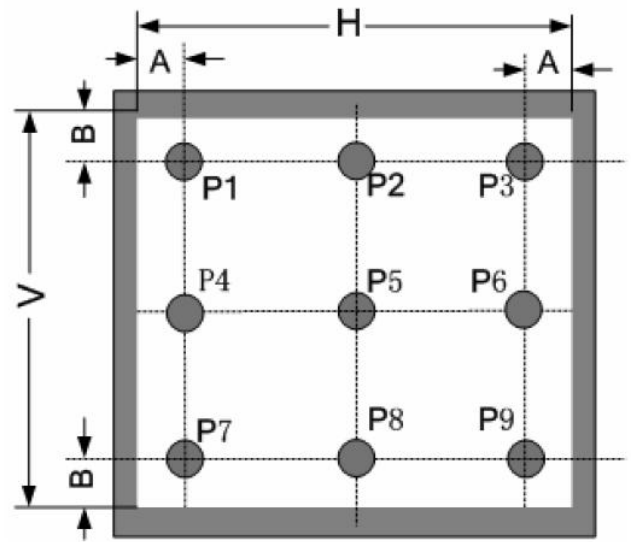
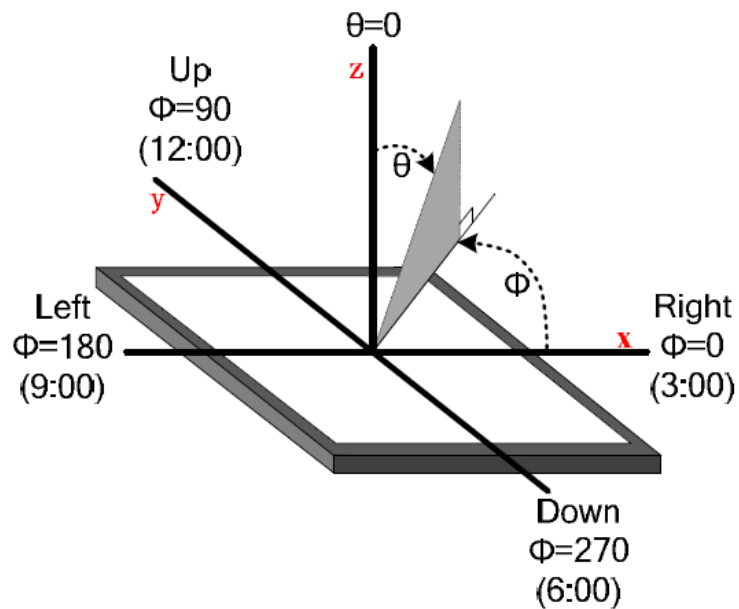

FIG.4. The definition of viewing angle

视角定义



■ INTERFACE DESCRIPTION

接口定义描述

NO. 接口 序号	Symbol 符号	I/O or connect to 输入/出 或 连接到	Description 描述	When not in use 不用 时
1	LEDK	LED driver	LED CATHODE	OPEN
2	LEDA	LED driver	LED ANODE	OPEN
3	YU(NC)	-	No connection	-
4	XR(NC)	-	No connection	-
5	YD(NC)	-	No connection	-
6	XL(NC)	-	No connection	-
7	VCC	Power supply	A power supply for the analog power. VCC = 2.3 ~ 4.8V. VCC input level should be same as VCI input level to avoid the level-mismatching at internal level shifter circuit. TYPE:2.8/3.3V	-
8	IOVCC	Power supply	A power supply for the I/O circuit. IOVCC= 1.65 ~ 3.3V. IOVCC must less than VCC and VCI. TYPE:1.8V/2.8/3.3V	-
9	LEDPWM	O	Backlight on/fff control pin. If use CABC function, the pin can connect to external LED driver IC. The output voltage range=0 to IOVCC.	OPEN
10	TE(NC)	-	No connection	-
11	IM0	I Host processor	Mode select pins. For the details,please refer to NOTE1	-
12	IM1	I Host processor		-
13	IM2(NC)	-	No connection	-
14	IM3(NC)	-	No connection	-
15	RESET	I Host processor	Reset pin. Setting either pin low initializes the LSI. Must be reset after power is supplied (Must be connected to GND or IOVCC).	-
16	DB23	I/O processor Host	Databus. For the details,please refer to NOTE1	OPEN
17	DB22			
18	DB21			
19	DB20			
20	DB19			
21	DB18			
22	DB17			
23	DB16			
24	DB15			
25	DB14			
26	DB13			
27	DB12			
28	DB11			
29	DB10			
30	DB09			
31	DB08			
32	DB07			

33	DB06	I/O Host processor	Databus. For the details, please refer to NOTE1	OPEN
34	DB05			
35	DB04			
36	DB03			
37	DB02			
38	DB01			
39	DB00			
40	RDX_E(NC)	-	No connection	-
41	WRX_DCX (NC)	-	No connection	-
42	DCX_SCL	I Host processor	DBI Type-B: Data / Command Selection pin DBI Type-C: When operate in serial interface, it serves as SCL (Serial Clock)	OPEN or IOVCC
43	CS	I Host processor	Chip select signal. Low: chip can be accessed; High: chip cannot be accessed.	GND or IOVCC
44	SDI	I Host processor	Serial data input pin in serial interface operation.	OPEN
45	SDO	I Host processor	Serial data output. Let it to open in MPU interface mode.	OPEN
46	NRD_VSYNC	I Host processor	DBI Type-B: Serves as a read signal and read data at the low level. DPI: Frame synchronizing signal.	GND or IOVCC
47	NWR_HSYNC	I Host processor	DBI Type-B: Serves as a write signal and write data at the low level. DPI: Line synchronizing signal.	GND or IOVCC
48	TE_ENABLE	I Host processor	DBI Type-B: Serves TE (Tearing Effect) function. DSI: Serves TE (Tearing Effect) function. MDDI: Serves TE (Tearing Effect) function. DPI: A data ENABLE signal in RGB I/F mode. Can't support TE function in this interface.(BS[1:0]=00)	GND
49	DOTCLK	I Host processor	DPI: Dot clock signal.	GND or IOVCC
50	DSI_LDO_ENB	NC	This pin is no function, please let it open.	OPEN
51	DSI_VSS	Power supply	MDDI/DSI analogy ground. DSI_VSS=0V. When using the COG method, connect to VSSA on the FPC to prevent noise.	-
52	DSI_D0N	I/O Host processor	In MDDI interface: MDDI Data differential signal input pins. Connect to a terminal resistance (100_) between DSI_D0P and DSI_D0N. (Data lane 0) In DSI interface: DSI Data differential signal input pins. (Data lane 0)	GND
53	DSI_D0P	I/O Host processor		
54	DSI_VSS	Power supply	MDDI/DSI analogy ground. DSI_VSS=0V. When using the COG method, connect to VSSA on the FPC to prevent noise.	-
55	DSI_D1N	I/O Host processor	In MDDI interface: MDDI Data differential signal input pins. Connect to a terminal resistance (100_) between DSI_D1P and DSI_D1N. (Data lane 1) In DSI interface: DSI Data differential signal input pins. (Data lane 1)	GND
56	DSI_D1P	I/O Host processor		

57	DSI_VSS	Power supply	MDDI/DSI analogy ground. DSI_VSS=0V. When using the COG method, connect to VSSA on the FPC to prevent noise.	-
58	DSI_CLKN	I Host processor	In MDDI interface: MDDI CLOCK differential signal input pins. Connect to a terminal resistance (100_) between DSI_CLKP and DSI_CLKN. In DSI interface: DSI CLOCK differential signal input pins.	OPEN or GND
59	DSI_CLKP	I Host processor		
60	DSI_VSS	Power supply	MDDI/DSI analogy ground. DSI_VSS=0V. When using the COG method, connect to VSSA on the FPC to prevent noise.	-
61	VCI	Power supply	A power supply for the main power, DC/DC converter VDD3 = 2.3 ~4.8V..TYPE:2.8/3.3V	-

NOTE1

IM1	IM0	MPU interface mode	DB pins
0	0	DPI/DBI TYPE-C (3 wire serial + RGB interface)	DB: 16/18/24 bit SDI/SDO
0	1	DSI interface	HS_CP, HS_CN, HS_D0P, HS_D0N, HS_D1P, HS_D1N
1	0	DBI TYPE-B	DB: 8/9/16/18/24 bit
1	1	MDDI interface (3 wire serial + MDDI interface)	HS_CP, HS_CN, HS_D0P, HS_D0N, HS_D1P, HS_D1N

Must be connected to VSSD or VDD1.

RGB interface

Data bus	Used	Unused
16-bit bus	DB21~17, DB13~8, DB5~1	DB23-22, DB16-14, DB7-6, DB0
18-bit bus	DB21~16, DB13~8, DB5~0	DB23-22, DB15-14, DB7-6
24-bit bus	DB23-D0	--

DBI TYPE-B interface

Data bus	Used	Unused
8-bit bus	DB7~0	DB23-8
9-bit bus	DB8~0	DB23-9
16-bit bus	DB15~0	DB23-16
18-bit bus	DB17~0	DB23-18
24-bit bus	DB23-D0	--

The unused pins can connect to VDD1, VSSD or open.

■ REFERENCE APPLICATION CIRCUIT**参考应用电路**

Please consult our technical department for detail information.

详细信息请联系我们的技术部

■ RELIABILITY TEST CONDITIONS

可靠性试验条件

No. 序号	Test Item 试验项目	Test Condition 试验条件	Inspection after test 判断标准
1	High Temperature Storage 高温存放	80±2°C/200 hours	Inspection after 2~4hours storage at room temperature, the sample shall be free from defects: 试验结束后,已测试的 LCD 样品必须在室内正常温湿度环境下放置 2~4 个小时以上才能进行功能和外观检查,样品不允许有以下缺陷: 1.Air bubble in the LCD; 模块中有气泡; 2.Sealleak; 封口松脱; 3.Non-display; 不显示; 4.missing segments; 漏笔 5.Glass crack; 玻璃破碎; 6.Current Idd is twice higher than initial value. 电流 Idd 大于初时值的 2 倍
2	Low Temperature Storage 低温存放	-30±2°C/200 hours	
3	High Temperature Operating 高温操作	70±2°C/120 hours	
4	Low Temperature Operating 低温操作	-20±2°C/120 hours	
5	Temperature Cycle storage 冷热循环存放	-20±2°C~25~70±2°C × 10cycles (30min.) (5min.) (30min.)	
6	Damp proof Test operating 防潮试验操作	50°C ± 5°C × 90%RH/120 hours	
7	Vibration Test 振荡试验	Frequency: 10Hz~55Hz~10Hz Amplitude: 1.5mm, X, Y, Z direction for total 3hours (Packing condition)	
8	Dropping test 跌落试验	Drop to the ground from 1m height, one time, every side of carton. (Packing condition)	
9	ESD test 静电试验	Voltage:±8KV R: 330Ω C: 150pF Air discharge, 10time	

Remark: 注意:

1.The test samples should be applied to only one test item.

每个被测试的模块只能用于其中的一个测试项目。

2.Sample size for each test item is 5~10pcs.

每个测试项目的样品数量为 5~10 片。

3.For Damp Proof Test, Pure water(Resistance > 10MΩ) should be used.

对于防潮试验, 试验箱的用水必须是电阻大于 10M 欧姆的纯水。

4.In case of malfunction defect caused by ESD damage, if it would be recovered to normal state after resetting, it would be judged as a good part.

如果由静电引起产品故障,当放置一段时间后能够恢复正常, 则不视为产品缺陷。

5.EL evaluation should be excepted from reliability test with humidity and temperature: Some defects such as black spot/blemish can happen by natural chemical reaction with humidity and Fluorescence EL has.

带 EL 片的可靠性测试在高温高湿条件下, 荧光粉会发生自然化学反应而产生黑点或瑕疵, 因此不在高温高湿条件测试范围内。

6.Failure Judgment Criterion: Basic Specification, Electrical Characteristic, Mechanical Characteristic, Optical Characteristic.

故障判断标准: 基本规格, 电气特性, 机械特性, 光电特性

■ INSPECTION CRITERION

检查标准

<p>TRULY[®] OUTGOING QUALITY STANDARD</p>	<p>PAGE 1 OF 4</p>
<p>TITLE:FUNCTIONAL TEST & INSPECTION CRITERIA</p>	<p>MDS Product</p>

This specification is made to be used as the standard acceptance/rejection criteria for Color mobile phone LCM.

1 Sample plan

Sampling plan according to GB/T2828.1-2003/ISO 2859-1: 1999 and ANSI/ASQC Z1.4-1993, normal level 2 and based on:

Major defect: AQL 0.65

Minor defect: AQL 1.5

2. Inspection condition

Viewing distance for cosmetic inspection is about 30cm with bare eyes, and under an environment of 20~40W light intensity, all directions for inspecting the sample should be within 45° against perpendicular line.

3. Definition of inspection zone in LCD.

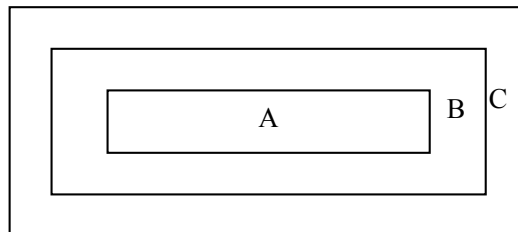

Zone A: character/Digit area

Zone B: viewing area except Zone A (ZoneA+ZoneB=minimum Viewing area)

Zone C: Outside viewing area (invisible area after assembly in customer's product)

Fig.1 Inspection zones in an LCD.

Note: As a general rule, visual defects in Zone C are permissible, when it is no trouble for quality and assembly of customer's product.

TRULY® OUTGOING QUALITY STANDARD	PAGE 2 OF 4
TITLE:FUNCTIONAL TEST & INSPECTION CRITERIA	MDS Product

4. Inspection standards

4.1 Major Defect

Item No	Items to be inspected	Inspection Standard	Classification of defects
4.1.1	All functional defects	1) No display 2) Display abnormally 3) Missing vertical, horizontal segment 4) Short circuit 5) Back-light no lighting, flickering and abnormal lighting.	Major
4.1.2	Missing	Missing component	
4.1.3	Outline dimension	Overall outline dimension beyond the drawing is not allowed.	

4.2 Cosmetic Defect

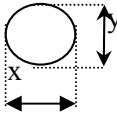
Item No	Items to be inspected	Inspection Standard	Classification of defects																											
4.2.1	Clear Spots	For dark/white spot, size Φ is defined as $\Phi = \frac{(x+y)}{2}$ 	Minor																											
	Black and white Spot defect Pinhole, Foreign Particle, Dirt under polarizer	1. <table border="1" data-bbox="427 1167 1161 1547"> <thead> <tr> <th rowspan="2">Zone Size(mm)</th> <th colspan="3">Acceptable Qty</th> </tr> <tr> <th>A</th> <th>B</th> <th>C</th> </tr> </thead> <tbody> <tr> <td>$\Phi \leq 0.10$</td> <td colspan="3">Ignore</td> </tr> <tr> <td>$0.10 < \Phi \leq 0.15$</td> <td colspan="3">2</td> </tr> <tr> <td>$0.15 < \Phi \leq 0.20$</td> <td colspan="3">1</td> </tr> <tr> <td>$\Phi > 0.20$</td> <td colspan="3">0</td> </tr> </tbody> </table>		Zone Size(mm)	Acceptable Qty			A	B	C	$\Phi \leq 0.10$	Ignore			$0.10 < \Phi \leq 0.15$	2			$0.15 < \Phi \leq 0.20$	1			$\Phi > 0.20$	0						
Zone Size(mm)	Acceptable Qty																													
	A	B	C																											
$\Phi \leq 0.10$	Ignore																													
$0.10 < \Phi \leq 0.15$	2																													
$0.15 < \Phi \leq 0.20$	1																													
$\Phi > 0.20$	0																													
	Dim Spots	2. <table border="1" data-bbox="427 1630 1137 2038"> <thead> <tr> <th rowspan="2">2. Zone Size(mm)</th> <th colspan="3">Acceptable Qty</th> </tr> <tr> <th>A</th> <th>B</th> <th>C</th> </tr> </thead> <tbody> <tr> <td>$\Phi \leq 0.2$</td> <td colspan="3">Ignore</td> </tr> <tr> <td>$0.20 < \Phi \leq 0.40$</td> <td colspan="3">3</td> </tr> <tr> <td>$0.40 < \Phi \leq 0.60$</td> <td colspan="3">2</td> </tr> <tr> <td>$0.60 < \Phi \leq 0.80$</td> <td colspan="3">1</td> </tr> <tr> <td>$0.80 < \Phi$</td> <td colspan="3">0</td> </tr> </tbody> </table>	2. Zone Size(mm)	Acceptable Qty			A	B	C	$\Phi \leq 0.2$	Ignore			$0.20 < \Phi \leq 0.40$	3			$0.40 < \Phi \leq 0.60$	2			$0.60 < \Phi \leq 0.80$	1			$0.80 < \Phi$	0			Minor
2. Zone Size(mm)	Acceptable Qty																													
	A	B	C																											
$\Phi \leq 0.2$	Ignore																													
$0.20 < \Phi \leq 0.40$	3																													
$0.40 < \Phi \leq 0.60$	2																													
$0.60 < \Phi \leq 0.80$	1																													
$0.80 < \Phi$	0																													

TRULY® OUTGOING QUALITY STANDARD	PAGE 3 OF 4
TITLE: FUNCTIONAL TEST & INSPECTION CRITERIA	MDS Product

4.2. Cosmetic Defect

Item No	Items to be inspected	Inspection Standard	Classification of defects																																	
4.2.2	Line defect Black line, White line, Foreign material under polarizer,	<table border="1"> <thead> <tr> <th colspan="2">Size(mm)</th> <th colspan="3">Acceptable Qty</th> </tr> <tr> <th rowspan="2">L(Length)</th> <th rowspan="2">W(Width)</th> <th colspan="3">Zone</th> </tr> <tr> <th>A</th> <th>B</th> <th>C</th> </tr> </thead> <tbody> <tr> <td>Ignore</td> <td>$W \leq 0.02$</td> <td colspan="3">Ignore</td> </tr> <tr> <td>$L \leq 3.0$</td> <td>$0.02 < W \leq 0.03$</td> <td colspan="3">2</td> </tr> <tr> <td>$L \leq 2.0$</td> <td>$0.03 < W \leq 0.05$</td> <td colspan="3">1</td> </tr> <tr> <td></td> <td>$0.05 < W$</td> <td colspan="3">Define as spot defect</td> </tr> </tbody> </table>	Size(mm)		Acceptable Qty			L(Length)	W(Width)	Zone			A	B	C	Ignore	$W \leq 0.02$	Ignore			$L \leq 3.0$	$0.02 < W \leq 0.03$	2			$L \leq 2.0$	$0.03 < W \leq 0.05$	1				$0.05 < W$	Define as spot defect			Minor
Size(mm)		Acceptable Qty																																		
L(Length)	W(Width)	Zone																																		
		A	B	C																																
Ignore	$W \leq 0.02$	Ignore																																		
$L \leq 3.0$	$0.02 < W \leq 0.03$	2																																		
$L \leq 2.0$	$0.03 < W \leq 0.05$	1																																		
	$0.05 < W$	Define as spot defect																																		
4.2.3	Polarizer scratch	<p>If the Polarizer scratch can be seen after mobile phone cover assembling or in the operating condition, judge by the line defect of 4.2.2.</p> <p>If the Polarizer scratch can be seen only in non-operating condition or some special angle, judge by the following.</p> <table border="1"> <thead> <tr> <th colspan="2">Size(mm)</th> <th colspan="3">Acceptable Qty</th> </tr> <tr> <th rowspan="2">L(Length)</th> <th rowspan="2">W(Width)</th> <th colspan="3">Zone</th> </tr> <tr> <th>A</th> <th>B</th> <th>C</th> </tr> </thead> <tbody> <tr> <td>Ignore</td> <td>$W \leq 0.03$</td> <td colspan="3">Ignore</td> </tr> <tr> <td>$5.0 < L \leq 10.0$</td> <td>$0.03 < W \leq 0.05$</td> <td colspan="3">2</td> </tr> <tr> <td>$L \leq 5.0$</td> <td>$0.05 < W \leq 0.08$</td> <td colspan="3">1</td> </tr> <tr> <td></td> <td>$0.08 < W$</td> <td colspan="3">0</td> </tr> </tbody> </table>	Size(mm)		Acceptable Qty			L(Length)	W(Width)	Zone			A	B	C	Ignore	$W \leq 0.03$	Ignore			$5.0 < L \leq 10.0$	$0.03 < W \leq 0.05$	2			$L \leq 5.0$	$0.05 < W \leq 0.08$	1				$0.08 < W$	0			Minor
Size(mm)		Acceptable Qty																																		
L(Length)	W(Width)	Zone																																		
		A	B	C																																
Ignore	$W \leq 0.03$	Ignore																																		
$5.0 < L \leq 10.0$	$0.03 < W \leq 0.05$	2																																		
$L \leq 5.0$	$0.05 < W \leq 0.08$	1																																		
	$0.08 < W$	0																																		
4.2.4	Polarize Air bubble	<p>Air bubbles between glass & polarizer</p> <table border="1"> <thead> <tr> <th rowspan="2">Size(mm) 2. Zone</th> <th colspan="3">Acceptable Qty</th> </tr> <tr> <th>A</th> <th>B</th> <th>C</th> </tr> </thead> <tbody> <tr> <td>$\Phi \leq 0.2$</td> <td colspan="3">Ignore</td> </tr> <tr> <td>$0.20 < \Phi \leq 0.30$</td> <td colspan="3">2</td> </tr> <tr> <td>$0.30 < \Phi \leq 0.50$</td> <td colspan="3">1</td> </tr> <tr> <td>$0.50 < \Phi$</td> <td colspan="3">0</td> </tr> </tbody> </table>	Size(mm) 2. Zone	Acceptable Qty			A	B	C	$\Phi \leq 0.2$	Ignore			$0.20 < \Phi \leq 0.30$	2			$0.30 < \Phi \leq 0.50$	1			$0.50 < \Phi$	0			Minor										
Size(mm) 2. Zone	Acceptable Qty																																			
	A	B	C																																	
$\Phi \leq 0.2$	Ignore																																			
$0.20 < \Phi \leq 0.30$	2																																			
$0.30 < \Phi \leq 0.50$	1																																			
$0.50 < \Phi$	0																																			

TRULY [®] OUTGOING QUALITY STANDARD	PAGE 4 OF 4
TITLE:FUNCTIONAL TEST & INSPECTION CRITERIA	MDS Product

4.3. Cosmetic Defect

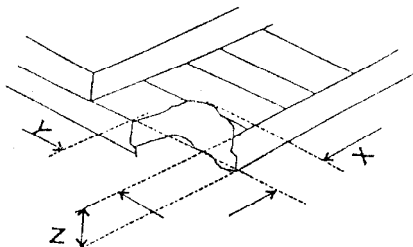
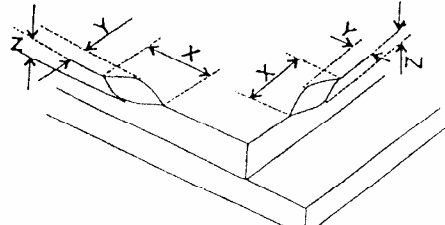
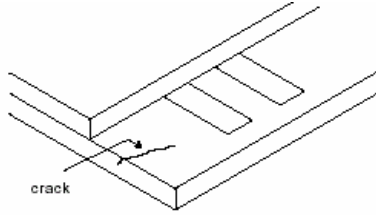
Item No	Items to be inspected	Inspection Standard	Classification of defects						
4.3.5	Glass defect	(i) Chips on corner  <table border="1" data-bbox="475 743 1118 837"> <tr> <td style="text-align: center;">X</td> <td style="text-align: center;">Y</td> <td style="text-align: center;">Z</td> </tr> <tr> <td style="text-align: center;">≤2.0</td> <td style="text-align: center;">≤S</td> <td style="text-align: center;">Disregard</td> </tr> </table> Notes: S=contact pad length Chips on the corner of terminal shall not be allowed to extend into the ITO pad or expose perimeter seal.	X	Y	Z	≤2.0	≤S	Disregard	Minor
		X	Y	Z					
		≤2.0	≤S	Disregard					
(ii) Usual surface cracks  <table border="1" data-bbox="454 1263 1139 1357"> <tr> <td style="text-align: center;">X</td> <td style="text-align: center;">Y</td> <td style="text-align: center;">Z</td> </tr> <tr> <td style="text-align: center;">≤3.0</td> <td style="text-align: center;"><Inner border line of the seal</td> <td style="text-align: center;">Disregard</td> </tr> </table>	X	Y	Z	≤3.0	<Inner border line of the seal	Disregard	Minor		
X	Y	Z							
≤3.0	<Inner border line of the seal	Disregard							
(iii) Crack Cracks tend to break are not allowed. 	Major								
4.3.6	Parts alignment	1) Not allow IC and FPC/heat-seal lead width is more than 50% beyond lead pattern. 2) Not allow chip or solder component is off center more than 50% of the pad outline.	Minor						
4.3.7	SMT	According to the <Acceptability of electronic assemblies> IPC-A-610C class 2 standard. Component missing or function defect are Major defect, the others are Minor defect.							

■ PRECAUTIONS FOR USING LCD MODULES

使用注意事项

1 Handling Precautions

处理注意事项

- 1.1 The display panel is made of glass and polarizer. As glass is fragile. It tends to become or chipped during handling especially on the edges. Please avoid dropping or jarring. Do not subject it to a mechanical shock by dropping it or impact.

显示屏由玻璃和偏光片组成。由于玻璃是脆的，使用过程中要特别注意边缘区。请防止跌落或振动。不能机械碰撞。

- 1.2 If the display panel is damaged and the liquid crystal substance leaks out, be sure not to get any in your mouth. If the substance contacts your skin or clothes, wash it off using soap and water.

如果显示屏损坏且液晶物质泄漏，切勿入口。如果液晶物质与皮肤或衣服接触，请使用肥皂和水冲洗。

- 1.3 Do not apply excessive force to the display surface or the adjoining areas since this may cause the color tone to vary. Do not touch the display with bare hands. This will stain the display area and degraded insulation between terminals (some cosmetics are determined to the polarizer).

请勿施加过大的压力于显示屏或连接部位，否则会引起色调变化。不要用手接触显示屏，这将弄脏显示区和降低端子之间的绝缘能力（一些外观是由偏光片决定的）。

- 1.4 The polarizer covering the display surface of the LCD module is soft and easily scratched. Handle this polarizer carefully. Do not touch, push or rub the exposed polarizers with anything harder than an HB pencil lead (glass, tweezers, etc.). Do not put or attach anything on the display area to avoid leaving marks on it. Condensation on the surface and contact with terminals due to cold will damage, stain or dirty the polarizer. After products are tested at low temperature they must be warmed up in a container before coming in to contact with room temperature air.

覆盖液晶显示模块显示平面的偏光片是软性且易被擦伤，请小心轻拿。请勿用任何硬度大于 HB 铅笔芯的物品（玻璃，镊子等）接触、撞压或摩擦裸露偏光片。不要放置或粘附物体在显示区域上以免留下痕迹。冷凝在表面和端子将会损坏或弄脏偏光片。产品在低温下测试之后，与室温空气接触之前必须在容器内升温。

- 1.5 If the display surface becomes contaminated, breathe on the surface and gently wipe it with a soft dry cloth. If it is heavily contaminated, moisten cloth with one of the following solvents

- Isopropyl alcohol

- Ethyl alcohol

Do not scrub hard to avoid damaging the display surface.

如果显示平面受污，可对平面吹热气且轻轻地用软性干布擦除。如果受污严重，用含下列一种溶剂的湿布擦除：

- 甘油

- 酒精

请勿用力擦拭以免损坏显示平面。

- 1.6 Solvents other than those above-mentioned may damage the polarizer. Especially, do not use the following.

- Water

- Ketone

- Aromatic solvents

Wipe off saliva or water drops immediately, contact with water over a long period of time may cause deformation or color fading. Avoid contact with oil and fats.

除以上提到的溶剂外，其他溶剂可能会损坏偏光片，特别要避免使用以下溶剂：

-水

-酮

-芳烃溶剂

立即擦掉唾液或水滴，长时间与水接触会引起变形或褪色。避免接触油和油脂。

- 1.7 Exercise care to minimize corrosion of the electrode. Corrosion of the electrodes is accelerated by water droplets, moisture condensation or a current flow in a high-humidity environment.

特别注意最小限度地减少电极腐蚀，电极腐蚀会因水滴、湿度冷凝或在高湿环境下通电而加速。

- 1.8 Install the LCD Module by using the mounting holes. When mounting the LCD module make sure it is free of twisting, warping and distortion. In particular, do not forcibly pull or bend the I/O cable or the backlight cable.

使用安装孔装配液晶显示模块，安装时一定不要弯曲、扭曲和变形。要特别注意不要用力拔，弯曲传输线或背光线。

- 1.9 Do not attempt to disassemble or process the LCD module.

请勿拆卸液晶显示模块。

- 1.10 NC terminal should be open. Do not connect anything.

悬空端应断开，不要连接任何器件。

- 1.11 If the logic circuit power is off, do not apply the input signals.

如果逻辑电路电源是断开的，不要施加输入信号。

- 1.12 Electro-Static Discharge Control, Since this module uses a CMOS LSI, the same careful attention should be paid to electrostatic discharge as for an ordinary CMOS IC. To prevent destruction of the elements by static electricity, be careful to maintain an optimum work environment.

由于液晶显示模块使用 CMOS 集成，要特别注意静电放电问题。对 CMOS 器件，要特别注意静电。为防止静电损坏，注意保持合宜的工作环境。

- Before removing LCM from its packing case or incorporating it into a set, be sure the module and your body have the same electric potential. Be sure to ground the body when handling the LCD modules.

-液晶显示模块移出包装盒和安装之前，要保证模块和人体具有相同的电位。处理模块时，可靠接地。

- Tools required for assembling, such as soldering irons, must be properly grounded. Make certain the AC power source for the soldering iron does not leak. When using an electric screwdriver to attach LCM, the screwdriver should be of ground potentiality to minimize as much as possible any transmission of electromagnetic waves produced sparks coming from the commutator of the motor.

- 使用工具如电烙铁，要可靠接地，并确保烙铁使用交流电，不要漏电。用电批固定模块时，电批应接地，尽可能降低电动换向器火花产生的电磁波。

- To reduce the amount of static electricity generated, do not conduct assembling and other work under dry conditions. To reduce the generation of static electricity be careful that the air in the work is not too dry. A relative humidity of 50%-60% is recommended. As far as possible make the electric potential of your work clothes and that of the work bench the ground potential.

- 为减少静电产生，不在干燥组装或其它操作。为降低静电，工作场地一定不要干燥。建议相对湿度为 50%-60%。尽可能使你的工作服和工作台接地。

- The LCD module is coated with a film to protect the display surface. Exercise care when peeling off this protective film since static electricity may be generated.

- 液晶显示模块表面有一个保护膜。需要小心操作以减少撕保护膜时静电的产生。

- 1.13 Since LCM has been assembled and adjusted with a high degree of precision, avoid applying excessive shocks to the module or making any alterations or modifications to it.

由于液晶显示模块由高精度装配和调节制成，应避免对模块过大的冲击或做任何更改。

- Do not alter, modify or change the shape of the tab on the metal frame.
- 不要改动金属架上的翼片形状。
- Do not make extra holes on the printed circuit board, modify its shape or change the positions of components to be attached.
- 不要在印制电路板上钻额外的孔，修改形状或更改印制线路板上元件的位置。
- Do not damage or modify the pattern writing on the printed circuit board.
- 不要更改或损坏印制线路板上的图案。
- Absolutely do not modify the zebra rubber strip (conductive rubber) or heat seal connector.
- 绝对不要更改斑马条（导电胶条）或导电纸连接器。
- Except for soldering the interface, do not make any alterations or modifications with a soldering iron.
- 除焊接接口外，不要用烙铁做任何更改。
- Do not drop, bend or twist the LCM.
- 不要扔、弯和扭模块。

2 Handling precaution for LCM 模块操作规范**2.1 LCM is easy to be damaged. Please note below and be careful for handling.**

液晶显示模块很容易被损坏. 请注意以下并小心操作

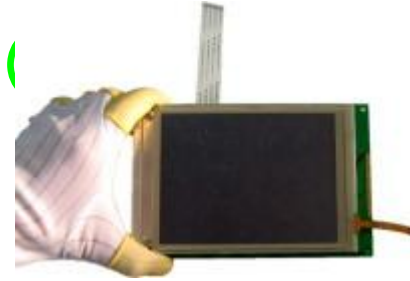
2.2 Correct handling: 正确操作:

As above picture, please handle with anti-static gloves around LCM edges.
像上面的图片,请戴抗静电手套,并拿模块边缘.

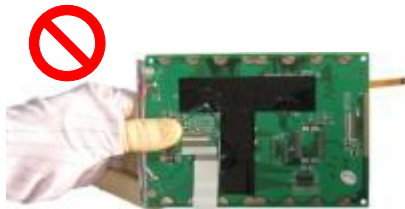
2.3 Incorrect handling: 错误操作:

Please don't touch IC directly.
不要直接地触摸 IC

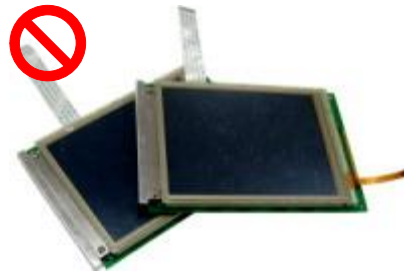

Please don't stack LCM.
不要把模块叠在一起



Please don't hold the surface of panel.
请不要拿着面板的表面



Please don't stretch interface of output, such as FPC cable.
请不要拉扯输出接口, 如接口线

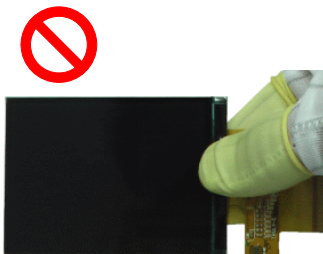

Please don't hold the surface of IC.
请不要拿着 IC 的表面

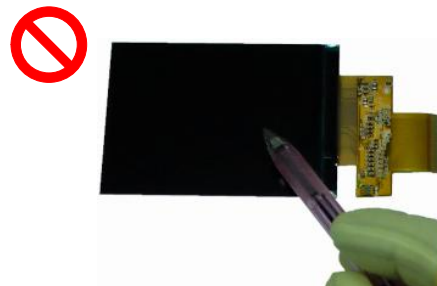

Please don't operate with sharp stick such as pens.
请不要用尖锐的物体来操作, 例如用笔尖

3 Storage Precautions 储存注意事项

3.1 When storing the LCD modules, the following precaution are necessary.

液晶显示模块的存储依照以下几点:

3.1.1 Store them in a sealed polyethylene bag. If properly sealed, there is no need for the desiccant.

使用聚乙烯袋密封, 如果密封得当, 不需要干燥剂。

3.1.2 Store them in a dark place. Do not expose to sunlight or fluorescent light, keep the temperature between 0°C and 35°C, and keep the relative humidity between 40%RH and 60%RH.

避光保存, 避免直接暴露在太阳光或黄光灯下, 保持温度在0~35摄氏度之间, 保持相对湿度在40%RH 和 60%RH之间。

3.1.3 The polarizer surface should not come in contact with any other objects (We advise you to store them in the anti-static electricity container in which they were shipped).

偏光片表面避免接触其他物质 (建议存放在货运防静电包装中)。

3.2 Others 其它

3.2.1 Liquid crystals solidify under low temperature (below the storage temperature range) leading to defective orientation or the generation of air bubbles (black or white). Air bubbles may also be generated if the module is subject to a low temperature.

液晶在低温会凝固 (低于储存温度范围以下), 会导致缺陷或产生气泡 (黑或白)。如果模块处于低温下, 也会产生气泡。

3.2.2 If the LCD modules have been operating for a long time showing the same display patterns, the display patterns may remain on the screen as ghost images and a slight contrast irregularity may also appear. A normal operating status can be regained by suspending use for some time. It should be noted that this phenomenon does not adversely affect performance reliability.

如果液晶显示模块长时间工作于同一个显示图案, 换屏时会出现鬼影, 也会出现轻微的对比度不均。停止使用一段时间后可恢复到正常状态。此现象不会严重影响性能可靠性。

3.2.3 To minimize the performance degradation of the LCD modules resulting from destruction caused by static electricity etc., exercise care to avoid holding the following sections when handling the modules.

工作为最小限度地降低由静电等导致液晶显示模块性能降低, 使用模块时慎重使用下列区域:

3.2.3.1 - Exposed area of the printed circuit board.

- 印制电路板裸露区域。

3.2.3.2 - Terminal electrode sections.

- 印制电路板引出端子区域。

4 USING LCD MODULES 使用液晶显示模块

4.1 Installing LCD Modules 安装液晶显示模块

The hole in the printed circuit board is used to fix LCM as shown in the picture below. Attend to the following items when installing the LCM.

印制线路板上的孔用来固定液晶显示屏, 如下图所示。安装液晶显示模块时, 注意以下事项:

4.1.1 Cover the surface with a transparent protective plate to protect the polarizer and LC cell.

贴一层透明保护膜来保护偏光片和液晶盒。

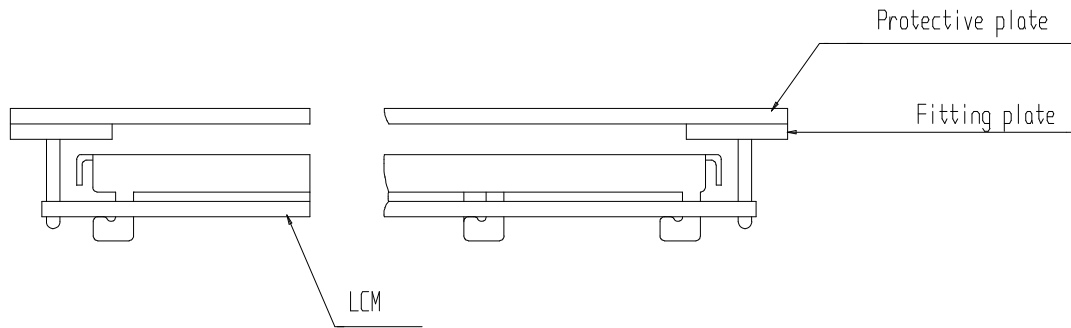

4.1.2 When assembling the LCM into other equipment, the spacer to the bit between the LCM and the fitting plate should have enough height to avoid causing stress to the module surface, refer to the individual specifications for measurements. The measurement tolerance should be $\pm 0.1\text{mm}$.

将模块安装进入其它设备时，模块和安装板之间间隔应有足够的高度以避免模块表面受压。参照专业度量技术标准。量度公差应是 ± 0.1 毫米。

4.2 Precaution for assemble the module with BTB connector:

用板对板连接器安装液晶显示模块注意事项:

Please note the position of the male and female connector position, don't assemble or assemble like the method which the following picture shows

请注意连接器的公母及连接位置，请勿出现下图所示的连接方式。

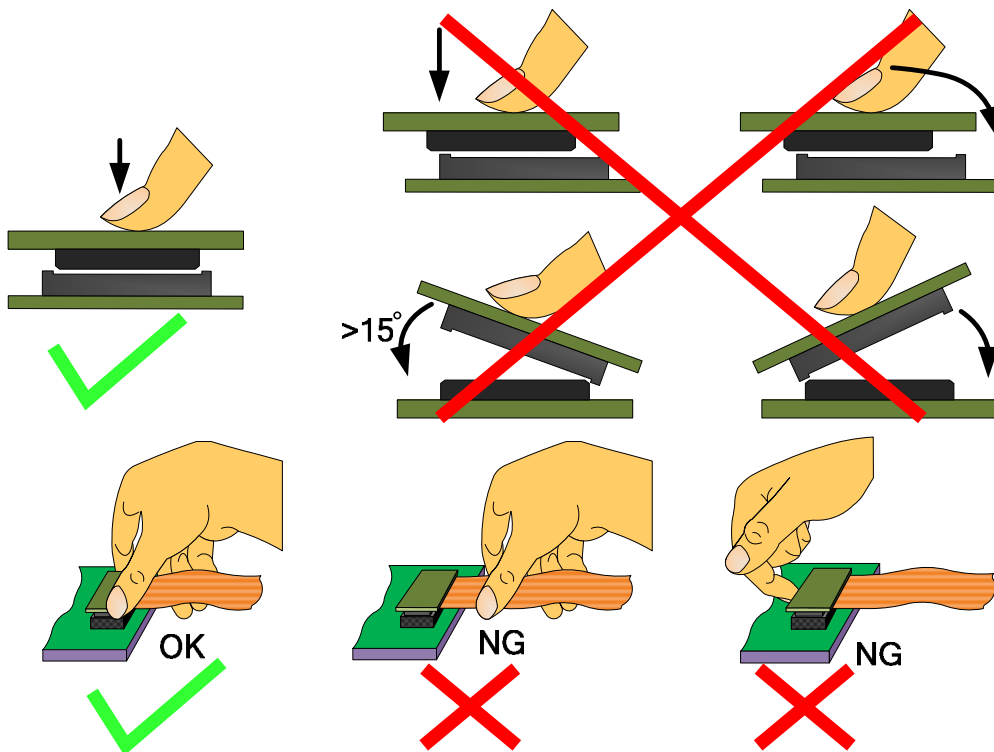

4.3 Precaution for soldering the LCM 焊接模块注意事项

	Manual soldering 手工焊接	Machine drag soldering 机器拖焊	Machine press soldering 机器压焊
No RoHS Product 非环保产品	290°C ~350°C. Time : 3-5S.	330°C ~350°C. Speed : 4-8 mm/s.	300°C ~330°C. Time : 3-6S. Press: 0.8~1.2Mpa
RoHS Product 环保产品	340°C ~370°C. Time : 3-5S.	350°C ~370°C. Time : 4-8 mm/s.	330°C ~360°C. Time : 3-6S. Press: 0.8~1.2Mpa

4.3.1 If soldering flux is used, be sure to remove any remaining flux after finishing to soldering operation (This does not apply in the case of a non-halogen type of flux). It is recommended that you protect the LCD surface with a cover during soldering to prevent any damage due to flux spatters.

如果使用助焊剂，完成焊接后一定要清除剩余的助焊剂（除非卤化物助焊剂）。建议焊接时用盖子保护显示屏面以避免因焊剂油溅出造成的任何损坏。

4.3.2 When soldering the electroluminescent panel and PC board, the panel and board should not be detached more than three times. This maximum number is determined by the temperature and time conditions mentioned above, though there may be some variance depending on the temperature of the soldering iron.

焊接背光源和线路板时，不应装卸多于三次。尽管焊接温度会有变化，但不应超过上面提到的焊接温度和时间最大值。

4.3.3 When remove the electroluminescent panel from the PC board, be sure the solder has completely melted, the soldered pad on the PC board could be damaged.

从线路板上移除背光源时，要保证焊锡已完全熔化，不要损坏线路板上的焊接位。

4.4 Precautions for Operation 工作运行注意事项:

4.4.1 Viewing angle varies with the change of liquid crystal driving voltage (VLCD). Adjust VLCD to show the best contrast.

视角应随液晶驱动电压 (VLCD) 变化而变化. 调整VLCD 可显示最好的对比度。

4.4.2 It is an indispensable condition to drive LCD's within the specified voltage limit since the higher voltage then the limit cause the shorter LCD life. An electrochemical reaction due to direct current causes LCD's undesirable deterioration, so that the use of direct current drive should be avoided.

在液晶驱动电压内来操作模块是必要的。超过限定电压会缩短液晶寿命。直流电会引起液晶的电化学反应，导致液晶老化，因此要避免直流电驱动液晶。

4.4.3 Response time will be extremely delayed at lower temperature than the operating temperature range and on the other hand at higher temperature LCD's show dark color in them. However those phenomena do not mean malfunction or out of order with LCD's, which will come back in the specified operating temperature.

液晶响应时间在低温时比常温要慢，高温时，液晶底色会深。然而，这并不是指液晶显示屏工作异常，显示屏在温度恢复时，效果会恢复正常。

4.4.4 If the display area is pushed hard during operation, the display will become abnormal. However, it will return to normal if it is turned off and then back on.

如果在运行过程中显示区受到挤压，显示将会异常。然而挤压中断，将恢复正常。

4.4.5 A slight dew depositing on terminals is a cause for electro-chemical reaction resulting in terminal open circuit. Usage under the maximum operating temperature, 50%RH or less is required.

接线端冷凝会引起电化学反应而断路。因此必须在最大的操作温度之内，湿度小于50%的条件下使用液晶显示模块。

4.4.6 Input logic voltage before apply analog high voltage such as LCD driving voltage when power on. Remove analog high voltage before logic voltage when power off the module. Input each signal after the positive/negative voltage becomes stable.

开机时，先让逻辑电压，再接通模拟高压，如显示屏驱动电压。关机时，先断开模拟高压，再关逻辑电压。正负电源都稳定后再送控制信号。

4.4.7 Please keep the temperature within the specified range for use and storage. Polarization degradation, bubble generation or polarizer peel-off may occur with high temperature and high humidity.

模块在操作和存储规格范围内使用。高温高湿可能会引起偏振退化，起泡，偏光片脱落等问题。

4.5 Safety 安全

4.5.1 It is recommended to crush damaged or unnecessary LCDs into pieces and wash them off with solvents such as acetone and ethanol, which should later be burned.

建议将损坏的液晶显示屏压成碎片，用溶剂诸如丙酮，乙醇冲洗掉，迟后烧掉。

4.5.2 If any liquid leaks out of a damaged glass cell and comes in contact with the hands, wash off thoroughly with soap and water.

如果任何液体从液晶盒泄漏出且与手接触，要用肥皂和水彻底清洗。

4.6 Limited Warranty 有限责任

Unless agreed between TRULY and the customer, TRULY will replace or repair any of its LCD modules which are found to be functionally defective when inspected in accordance with TRULY LCD acceptance standards (copies available upon request) for a period of one year from date of production. Cosmetic/visual defects must be returned to TRULY within 90 days of shipment. Confirmation of such date shall be based on data code on product. The warranty liability of TRULY limited to repair and/or replace on the terms set forth above. TRULY will not be responsible for any subsequent or consequential events.

除信利和客户之间另有协议外，自生产之日起一年内，根据信利的液晶显示屏品质标准，信利将对有功能缺陷的液晶显示模块换货或返工。

外观/视觉缺陷产品，必须在出货后90天内归还信利。以产品上标识日期为准。信利保修责任仅限于对符合上述规定的货品进行返工和/或换货。对此后发生的任何情况，信利均不承担任何责任。

4.7 Return LCM under warranty 模块保修

4.7.1 No warranty can be granted if the precautions stated above have been disregarded. The typical examples of violations are :

保修是以上述注意事项未被忽视为先决条件的。典型的违反例子如下：

4.7.1.1 - Broken LCD glass.

-断裂的液晶显示屏玻璃。

4.7.1.2 - PCB eyelet is damaged or modified.

-印制线路板孔修改或损坏。

4.7.1.3 -PCB conductors damaged.

-线路板导体损坏。

4.7.1.4 - Circuit modified in any way, including addition of components.

-线路随意变更，包括元件变化。

4.7.1.5 - PCB tampered with by grinding, engraving or painting varnish.

-印制电路板已修改，如研磨，雕刻，绘涂等。

4.7.1.6 - Soldering to or modifying the bezel in any manner.

-焊接或变动模块

4.7.2 Module repairs will be invoiced to the customer upon mutual agreement. Modules must be returned with sufficient description of the failures or defects. Any connectors or cable installed by the customer must be removed completely without damaging the PCB eyelet, conductors and terminals.

模块维修清单将按双方协议送呈客户。模块详细缺陷描述须模块一并退回。顾客安装的连接器或电缆必须在不破坏线路板孔，线路和引线端条件下全部移去。

■ PACKING SPECIFICATION

包装规格书

Please consult our technical department for detail information.

详细信息请联系我们的技术部

■ PRIOR CONSULT MATTER

提前商议事项

- 1 For Truly standard products, we keep the right to change material, process ... for improving the product property without prior notice to our customer.
对于信利的标准产品，我们保留在不通知客户的情况下，为提高产品性能而改变原材料及加工方法等的权利。
- 2 For OEM products, if any changes are needed which may affect the product property, we will consult with our customer in advance.
对于 OEM 产品，如果需要做任何会影响到产品性能的改变，我们会提前和客户商议。
- 3 If you have special requirement about reliability condition, please let us know before you start the test on our samples.
如对可靠性条件有特殊要求，请在模块测试前通知我们。

■ FACTORY CONTACT INFORMATION

工厂联系信息

FACTORY NAME: TRULY SEMICONDUCTORS LTD.

工厂名称:信利半导体有限公司

FACTORY ADDRESS: Truly Industrial Area, ShanWei City,GuangDong,China

工厂地址: 中国广东省汕尾市信利工业城

P.C: 516600 **URL:** <http://www.truly.com.hk> <http://www.trulysemi.com>

邮政编码: 516600 : 网站:<http://www.truly.com.hk> <http://www.trulysemi.com>