

**PRODUCT** : LCD MODULE

**MODEL NO.** : TFT-G240320LTSW-118W-E

**SUPPLIER** : TRULY SEMICONDUCTORS LTD.

**DATE** : August 31, 2010



CERT. No. QAC0946535 (ISO9001) CERT. No. HKG002005 (ISO14001)

# SPECIFICATION

Revision:1.3

**TFT-G240320LTSW-118W-E**

This module uses ROHS material

This specification maybe changed without any notice in order to improve performance or quality etc. Please contact TRULY R&D department for update specification and product status before design for this product or release the order.

**TRULY SEMICONDUCTORS LTD:**

**CUSTOMER:**

Quality Assurance Department: \_\_\_\_\_  
Approved by:  
Technical Department: \_\_\_\_\_

Approved by:



# CONTENTS

- GENERAL INFORMATION
- EXTERNAL DIMENSIONS
- ABSOLUTE MAXIMUM RATINGS
- ELECTRICAL CHARACTERISTICS
- TIMING OF POWER SUPPLY
- BACKLIGHT CHARACTERISTICS
- ELECTRO-OPTICAL CHARACTERISTICS
- INTERFACE DESCRIPTION
- REFERENCE APPLICATION CIRCUIT
- REFERENCE INITIAL CODE
- RELIABILITY TEST
- INSPECTION CRITERION
- PRECAUTIONS FOR USING LCD MODULES
- PACKING SPECIFICATION
- PRIOR CONSULT MATTER
- FACTORY CONTACT INFORMATION

<b>WRITTEN BY</b>	<b>CHECKED BY</b>	<b>APPROVED BY</b>
YU JI PING	ZHANG SHU HANG	ZHU JIN BAO

### ■ GENERAL INFORMATION

Item	Contents	Unit
LCD type	TFT TRANSMISSIVE	/
Viewing direction	9:00	3:00O' Clock(Good viewing)
Glass area (W × H)	57.54 × 79.2	mm <sup>2</sup>
Viewing area (W×H)	50.6 × 66.8	mm <sup>2</sup>
Active area (W×H)	48.6 × 64.8	mm <sup>2</sup>
Number of Dots	240 (RGB) × 320	/
Pixel size(W×H)	0.2025 × 0.2025	mm <sup>2</sup>
Driver IC	SSD1289	/
Backlight Type	LED	/
Module Power consumption	360	mw
Interface Type	System parallel interface /Serial Bus System Interface / RGB interface	/
Input voltage	2.8	V

### ■ EXTERNAL DIMENSIONS

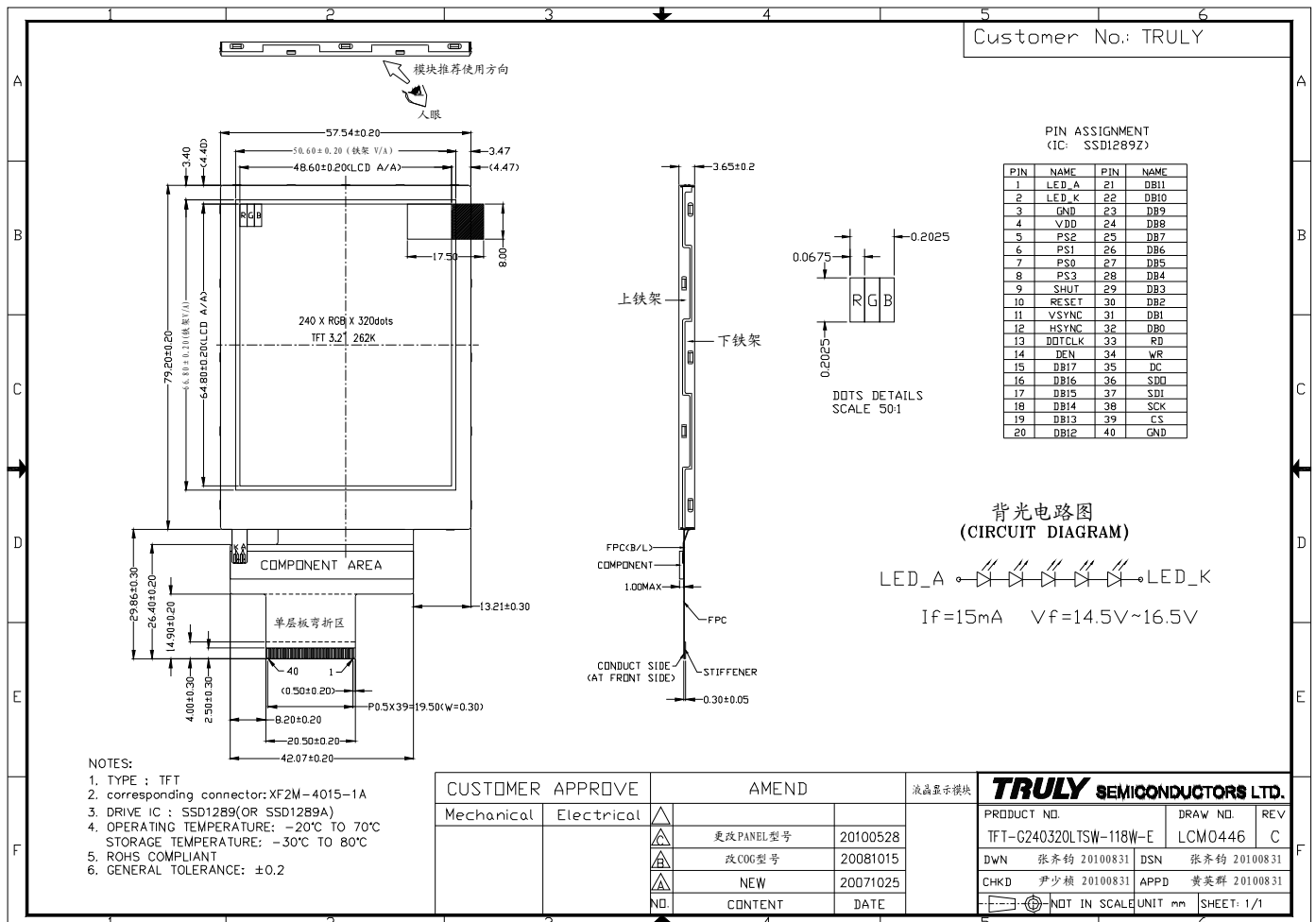

**■ABSOLUTE MAXIMUM RATINGS**

Parameter	Symbol	Min	Max	Unit
Supply voltage	V <sub>DD</sub>	-0.3	4.0	V
Input voltage	V <sub>IN</sub>	V <sub>SS</sub> -0.3	5.0	V
Operating temperature	T <sub>OP</sub>	-20	70	°C
Storage temperature	T <sub>ST</sub>	-30	80	°C
Humidity	RH		90%(Max60°C)	RH

**■ELECTRICAL CHARACTERISTICS**

## DC CHARACTERISTICS

Parameter	Symbol	Min	Typ	Max	Unit
Supply voltage for logic	V <sub>DD</sub> -V <sub>SS</sub>	2.5	2.8	3.6	V
Input Current	I <sub>dd</sub>	---	10.98	21.96	mA
Input voltage 'H' level	V <sub>IH</sub>	0.9 V <sub>DD</sub>	---	V <sub>DD</sub>	V
Input voltage 'L' level	V <sub>IL</sub>	0	---	0.1 V <sub>DD</sub>	V
Output voltage 'H' level	V <sub>OH</sub>	0.8 V <sub>DD</sub>	---	V <sub>DD</sub>	V
Output voltage 'L' level	V <sub>OL</sub>	0	---	0.2 V <sub>DD</sub>	V

**■ TIMING OF POWER SUPPLY**

PLEASE REFER TO THE DRIVER IC SPECIFICATION.

**■ BACKLIGHT CHARACTERISTICS**

Item	Symbol	Min.	Typ.	Max.	Unit	Condition
Forward voltage	V <sub>f</sub>	14.5	15.5	16.5	V	If=15 mA Ta=25°C
Luminance	L <sub>v</sub>	2500	-	-	cd/m <sup>2</sup>	
Number of LED	-	5			Piece	-
Connection mode	S	Series			-	-

**■ELECTRO-OPTICAL CHARACTERISTICS**

Item	Symbol	Condition	Min	Typ	Max	Unit	Remark	Note
Response time	Tr+Tf	$\theta=0^\circ$ $\varnothing=0^\circ$ $T_a=25^\circ\text{C}$	---	30.6	46	ms	FIG 1.	4
Contrast ratio	Cr		316	632	---	---	FIG 2.	1
Luminance uniformity	$\delta$ WHITE		78	87	---	%	FIG 2.	3
Surface Luminance	Lv		180	225	---	cd/m <sup>2</sup>	FIG 2.	2
Viewing angle range	$\theta$	$\varnothing = 90^\circ$	70	80	---	deg	FIG 3.	6
		$\varnothing = 270^\circ$	70	80	---	deg	FIG 3.	
		$\varnothing = 0^\circ$	70	80	---	deg	FIG 3.	
		$\varnothing = 180^\circ$	70	80	---	deg	FIG 3.	
CIE (x, y) chromaticity	Red	x	0.569	0.619	0.669	FIG 2.	5	
		y	0.298	0.348	0.398			
	Green	x	0.282	0.332	0.382			
		y	0.551	0.601	0.651			
	Blue	x	0.095	0.145	0.195			
		y	0.004	0.054	0.104			
	White	x	0.238	0.298	0.358			
		y	0.264	0.324	0.384			

Note 1. Contrast Ratio(CR) is defined mathematically as For more information see FIG 2.

$$\text{Contrast Ratio} = \frac{\text{Average Surface Luminance with all white pixels (P1, P2, P3, P4, P5)}}{\text{Average Surface Luminance with all black pixels (P1, P2, P 3,P4, P5)}}$$

Note 2. Surface luminance is the LCD surface from the surface with all pixels displaying white. For more information see FIG 2.

$$L_v = \text{Average Surface Luminance with all white pixels (P1, P2, P 3, P4, P5)}$$

Note 3. The uniformity in surface luminance ,  $\delta$  WHITE is determined by measuring luminance at each test position 1 through 5, and then dividing the maximum luminance of 5 points luminance by minimum luminance of 5 points luminance. For more information see FIG 2.

$$\delta \text{ WHITE} = \frac{\text{Minimum Surface Luminance with all white pixels (P1, P2, P 3, P4, P5)}}{\text{Maximum Surface Luminance with all white pixels (P1, P2, P 3, P4, P5)}}$$

Note 4. Response time is the time required for the display to transition from White to black(Rise Time, Tr) and from black to white(Decay Time, Tf). For additional information see FIG 1. The test equipment is Autronic-Melchers’s ConoScope. Series.

Note 5. CIE (x, y) chromaticity, The x, y value is determined by measuring luminance at each test position 1 through 5,and then make average value.

Note 6. Viewing angle is the angle at which the contrast ratio is greater than 2. For TFT module the contrast ratio is greater than 10. The angles are determined for the horizontal or x axis and the vertical or y axis with respect to the z axis which is normal to the LCD surface. For more information see FIG 3.

Note 7. For viewing angle and response time testing, the testing data is base on Autronic-Melchers’s

ConoScope. Series Instruments For contrast ratio, Surface Luminance, Luminance uniformity, CIE The test data is base on TOPCON's BM-5 photo detector.

**FIG. 1 The definition of Response Time**

The response time is defined as the following figure and shall be measured by switching the input signal for "black" and "white".

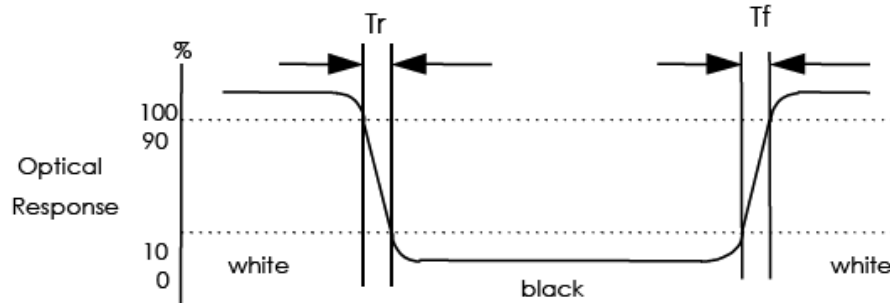

**FIG. 2 Measuring method for Contrast ratio, surface luminance, Luminance uniformity , CIE (x, y) chromaticity**

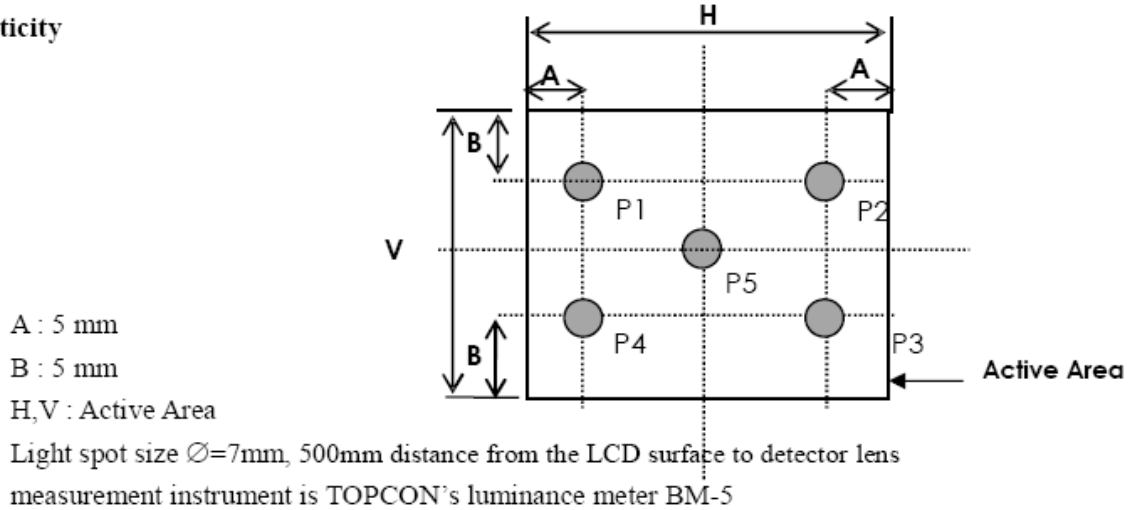

**FIG. 3 The definition of viewing angle**

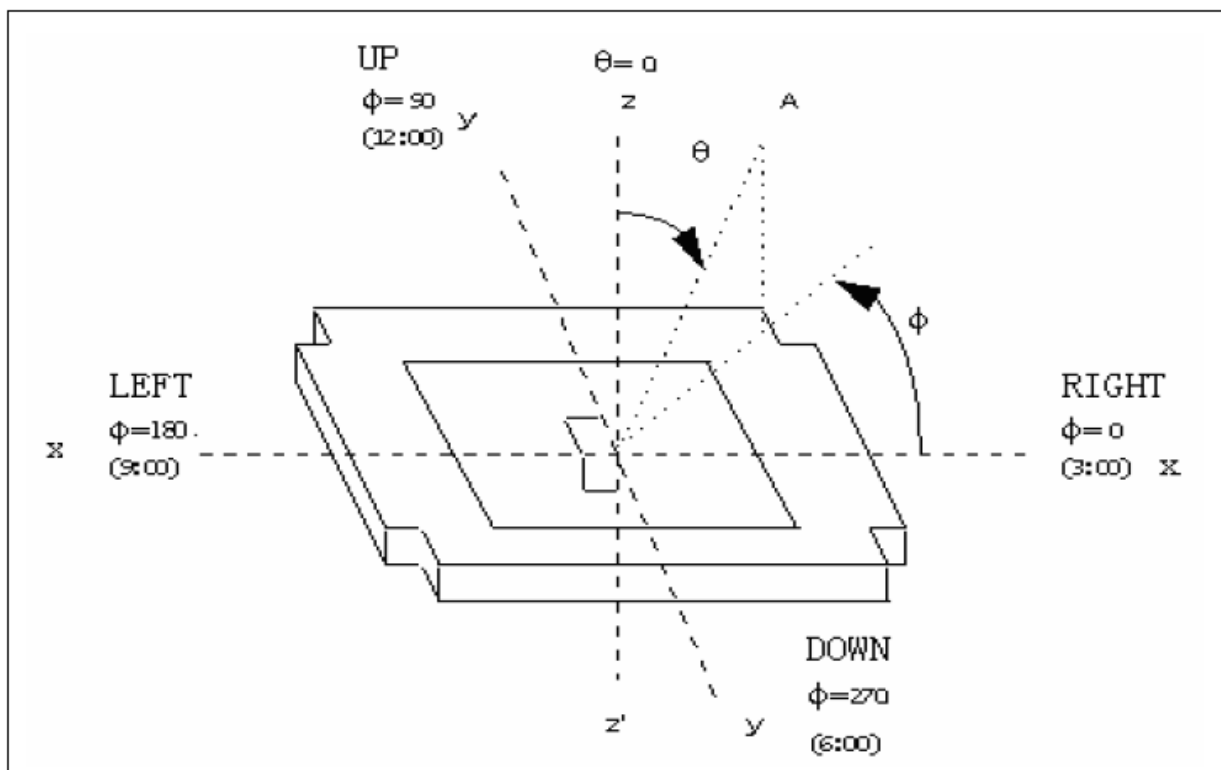



## ■ INTERFACE DESCRIPTION

Pin No.	Symbol	Level	Description	When not in use																																																																						
1	LED-A	---	LED Backlight Anode	-																																																																						
2	LED-K	---	LED Backlight Cathode	-																																																																						
3	GND	0V	Ground	-																																																																						
4	VDD	2.5~3.6V	Logic power supply.																																																																							
5	PS2	H/L	<table border="1"> <thead> <tr> <th>PS3</th> <th>PS2</th> <th>PS1</th> <th>PS0</th> <th>Interface Mode</th> </tr> </thead> <tbody> <tr> <td>1</td> <td>1</td> <td>1</td> <td>1</td> <td>3-wire SPI</td> </tr> <tr> <td>1</td> <td>1</td> <td>1</td> <td>0</td> <td>4-wire SPI</td> </tr> <tr> <td>1</td> <td>0</td> <td>1</td> <td>1</td> <td>16-bit 6800 parallel interface</td> </tr> <tr> <td>1</td> <td>0</td> <td>1</td> <td>0</td> <td>8-bit 6800 parallel interface</td> </tr> <tr> <td>1</td> <td>0</td> <td>0</td> <td>1</td> <td>16-bit 8080 parallel interface</td> </tr> <tr> <td>1</td> <td>0</td> <td>0</td> <td>0</td> <td>8-bit 8080 parallel interface</td> </tr> <tr> <td>0</td> <td>1</td> <td>1</td> <td>1</td> <td>18-bits 6800 parallel interface</td> </tr> <tr> <td>0</td> <td>1</td> <td>1</td> <td>0</td> <td>9-bits 6800 parallel interface</td> </tr> <tr> <td>0</td> <td>1</td> <td>0</td> <td>1</td> <td>18-bit 8080 parallel interface</td> </tr> <tr> <td>0</td> <td>1</td> <td>0</td> <td>0</td> <td>9-bit 8080 parallel interface</td> </tr> <tr> <td>0</td> <td>0</td> <td>1</td> <td>1</td> <td>Reserved</td> </tr> <tr> <td>0</td> <td>0</td> <td>1</td> <td>0</td> <td>Reserved</td> </tr> <tr> <td>0</td> <td>0</td> <td>0</td> <td>1</td> <td>18-bit RGB interface + 4-wire SPI</td> </tr> </tbody> </table>	PS3	PS2	PS1	PS0	Interface Mode	1	1	1	1	3-wire SPI	1	1	1	0	4-wire SPI	1	0	1	1	16-bit 6800 parallel interface	1	0	1	0	8-bit 6800 parallel interface	1	0	0	1	16-bit 8080 parallel interface	1	0	0	0	8-bit 8080 parallel interface	0	1	1	1	18-bits 6800 parallel interface	0	1	1	0	9-bits 6800 parallel interface	0	1	0	1	18-bit 8080 parallel interface	0	1	0	0	9-bit 8080 parallel interface	0	0	1	1	Reserved	0	0	1	0	Reserved	0	0	0	1	18-bit RGB interface + 4-wire SPI	-
PS3	PS2	PS1	PS0	Interface Mode																																																																						
1	1	1	1	3-wire SPI																																																																						
1	1	1	0	4-wire SPI																																																																						
1	0	1	1	16-bit 6800 parallel interface																																																																						
1	0	1	0	8-bit 6800 parallel interface																																																																						
1	0	0	1	16-bit 8080 parallel interface																																																																						
1	0	0	0	8-bit 8080 parallel interface																																																																						
0	1	1	1	18-bits 6800 parallel interface																																																																						
0	1	1	0	9-bits 6800 parallel interface																																																																						
0	1	0	1	18-bit 8080 parallel interface																																																																						
0	1	0	0	9-bit 8080 parallel interface																																																																						
0	0	1	1	Reserved																																																																						
0	0	1	0	Reserved																																																																						
0	0	0	1	18-bit RGB interface + 4-wire SPI																																																																						
6	PS1	H/L																																																																								
7	PS0	H/L																																																																								
8	PS3	H/L																																																																								
9	SHUT	H/L	When using the RGB interface, it is a input pin to put the driver into sleep mode. A sharp falling edge must be provided to such pin when IC power on. - Connect to VDD for sleep mode - Connect to VSS for normal operating mode This pin has no effect in system interface and should be connected to VDD/VSS	VDD or VSS																																																																						
10	RESET	H/L	System reset pin. - Connect to VDD when not used	VDD																																																																						
11	VSYNC	H/L	Frame synchronization signal.	VDD or VSS																																																																						
12	HSYNC	H/L	Line synchronization signal.	VDD or VSS																																																																						
13	DOTCLK	H/L	Dot-clock signal and oscillator source. A non-stop external clock must be provided to that pin even at front or black porch non-display period.	VDD or VSS																																																																						
14	DEN	H/L	Display enable pin from controller. Data will be treated as dummy regardless the DEN status during front/back porch setting at registers R16 and R17.	VDD																																																																						
15~32	DB17~DB0	H/L	For parallel mode, 8/9/16/18 bit interface. For generic mode, RGB interface. Unused pins must be float or connect to VSS.	VSS																																																																						
33	RD	H/L	68-system : E (enable signal) 80-system : /RD (read strobe signal) Serial mode : Not used and should be connected to V <sub>DDIO</sub> or V <sub>SS</sub>	VDD or VSS																																																																						
34	WR	H/L	68-system : /WR (indicates read cycle when High, write cycle when Low) 80-system : WR (write strobe signal) Serial mode : Not used and should be connected to V <sub>DDIO</sub> or V <sub>SS</sub>	VDD or VSS																																																																						

35	DC	H/L	Data or command	VDD or VSS
36	SDO	H/L	Data output pin in serial mode.	OPEN
37	SDI	H/L	Data input pin in serial mode.	OPEN
38	SCK	H/L	Clock pin of serial interface.	OPEN
39	CS	H/L	Chip select pin	-
40	GND	0V	Ground	-

## ■ APPLICATION CIRCUIT

Please consult our technical department for detail information.

## ■ INITIAL CODE

Please consult our technical department for detail information.

## ■ RELIABILITY TEST

No.	Test Item	Test Condition	Inspection after test
1	High Temperature Storage	80±2°C/200 hours	Inspection after 2~4hours storage at room temperature, the sample shall be free from defects: 1.Air bubble in the LCD; 2.Sealleak; 3.Non-display; 4.missing segments; 5.Glass crack; 6.Current Idd is twice higher than initial value.
2	Low Temperature Storage	-30±2°C/200 hours	
3	High Temperature Operating	70±2°C/120 hours	
4	Low Temperature Operating	-20±2°C/120 hours	
5	Temperature Cycle	-20±2°C~25~70±2°C×10cycles (30min.) (5min.) (30min.)	
6	Damp Proof Test	50°C±5°C×90%RH/120 hours	
7	Vibration Test	Frequency: 10Hz~55Hz~10Hz Amplitude: 1.5mm, X, Y, Z direction for total 3hours (Packing condition)	
8	Drooping test	Drop to the ground from 1m height, one time, every side of carton. (Packing condition)	
9	ESD test	Voltage:±8KV R: 330Ω C: 150pF Air discharge, 10time	

### Remark:

- The test samples should be applied to only one test item.
- Sample size for each test item is 5~10pcs.
- For Damp Proof Test, Pure water(Resistance>10MΩ) should be used.
- In case of malfunction defect caused by ESD damage, if it would be recovered to normal state after resetting, it would be judge as a good part.  
Using ionizer(an antistatic blower) is recommended at working area in order to reduce electro-static voltage.  
When removing protection film from LCM panel, peel off the tag slowly( recommended more than one second) while blowing with ionizer toward the peeling face to minimize ESD which may damage electrical circuit.
- EL evaluation should be excepted from reliability test with humidity and temperature: Some defects such as black spot/blemish can happen by natural chemical reaction with humidity and Fluorescence EL has.
- Please use automatic switch menu(or roll menu) testing mode when test operating mode.

**■ INSPECTION CRITERION**

OUTGOING QUALITY STANDARD	P.1 of 5
---------------------------	----------

TITLE:FUNCTIONAL TEST & INSPECTION CRITERIA	Normal LCM Product
---	--------------------

This specification is made to be used as the standard acceptance/rejection criteria for Normal LCM Product.

1 Sample plan

Sampling plan according to GB/T2828.1-2003/ISO 2859-1: 1999 and ANSI/ASQC Z1.4-1993, normal level 2 and based on:

Major defect: AQL 0.65

Minor defect: AQL 1.5

2. Inspection condition

- Viewing distance for cosmetic inspection is about 30cm with bare eyes, and under an environment of 20~40W light intensity, all directions for inspecting the sample should be within 45 ° against perpendicular line. (Normal temperature 20~25°C and normal humidity 60±15%RH).

- Driving voltage

The Vop value from which the most optimal contrast can be obtained near the specified Vop in the specification (Within ±0.5V of the typical value at 25°C.).

3. Definition of inspection zone in LCD.

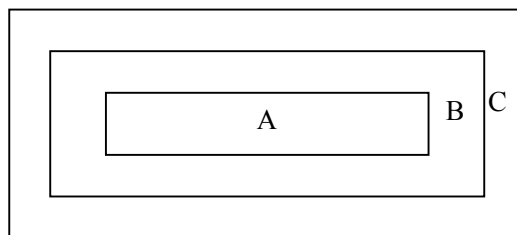

Zone A: character/Digit area

Zone B: viewing area except Zone A (ZoneA+ZoneB=minimum Viewing area)

Zone C: Outside viewing area (invisible area after assembly in customer's product)

Fig.1 Inspection zones in an LCD.

Note: As a general rule, visual defects in Zone C are permissible, when it is no trouble for quality and assembly of customer's product.

<b>TRULY</b> ® OUTGOING QUALITY STANDARD	P.2 of 5
TITLE:FUNCTIONAL TEST & INSPECTION CRITERIA	Normal LCM Product

## 4. Inspection Standard

### 4.1 Major Defect

Item No	Items to be inspected	Inspection Standard	Classification of defects
4.1.1	All functional defects	1) No display 2) Display abnormally 3) Missing vertical, horizontal segment 4) Short circuit 5) Back-light no lighting, flickering and abnormal lighting.	Major
4.1.2	Missing	Missing component	
4.1.3	Outline dimension	Overall outline dimension beyond the drawing is not allowed.	

### 4. 2 Cosmetic Defect

#### 4.2.1 Module Cosmetic Criteria

No.	Item	Judgement Criterion	Partition
1	Difference in Spec.	None allowed	Major
2	Pattern peeling	No substrate pattern peeling and floating	Major
3	Soldering defects	No soldering missing No soldering bridge No cold soldering	Major Major Minor
4	Resist flaw on Printed Circuit Boards	visible copper foil (Ø0.5mm or more) on substrate pattern	Minor
5	Accretion of metallic Foreign matter	No accretion of metallic foreign matters (Not exceed Ø0.2mm)	Minor Minor
6	Stain	No stain to spoil cosmetic badly	Minor
7	Plate discoloring	No plate fading, rusting and discoloring	Minor
8	Solder amount	a. Soldering side of PCB Solder to form a 'Filet' all around the lead. Solder should not hide the lead form perfectly. (too much)	Minor
	1. Lead parts	b. Components side ( In case of 'Through Hole PCB' )  Solder to reach the Components side of PCB.	
	2. Flat packages	Either 'Toe' (A) or 'Seal' (B) of the lead to be covered by 'Filet'.  Lead form to be assume over solder.	Minor
	3. Chips	$(3/2) H \geq h \geq (1/2) H$	Minor

OUTGOING QUALITY STANDARD		P.3 of 5		
TITLE:FUNCTIONAL TEST & INSPECTION CRITERIA		Normal LCM Product		
9	Solder ball/Solder splash	a. The spacing between solder ball and the conductor or solder pad $h \geq 0.13\text{mm}$ . The diameter of solder ball $d \leq 0.15\text{mm}$ . b. The quantity of solder balls or solder Splashes isn't beyond 5 in $600\text{mm}^2$ . c. Solder balls/Solder splashes do not violate minimum electrical clearance. d. Solder balls/Solder splashes must be entrapped/encapsulated Or attached to the metal surface .  NOTE: Entrapped/encapsulated/attached is intended to mean that normal service environment of the product will not cause a solder ball to become dislodged.		Minor  Minor  Major  Minor

#### 4.2.2 Cosmetic Criteria (Non-Operating)

No.	Defect	Judgment Criterion	Partition										
1	Spots	In accordance with <i>Screen Cosmetic Criteria (Operating) No.1.</i>	Minor										
2	Lines	In accordance with <i>Screen Cosmetic Criteria (Operating) No.2.</i>	Minor										
3	Bubbles in polarizer	<table border="1"> <thead> <tr> <th>Size : d mm</th> <th>Acceptable Qty in active area</th> </tr> </thead> <tbody> <tr> <td><math>d \leq 0.3</math></td> <td>Disregard</td> </tr> <tr> <td><math>0.3 &lt; d \leq 1.0</math></td> <td>3</td> </tr> <tr> <td><math>1.0 &lt; d \leq 1.5</math></td> <td>1</td> </tr> <tr> <td><math>1.5 &lt; d</math></td> <td>0</td> </tr> </tbody> </table>	Size : d mm	Acceptable Qty in active area	$d \leq 0.3$	Disregard	$0.3 < d \leq 1.0$	3	$1.0 < d \leq 1.5$	1	$1.5 < d$	0	Minor
Size : d mm	Acceptable Qty in active area												
$d \leq 0.3$	Disregard												
$0.3 < d \leq 1.0$	3												
$1.0 < d \leq 1.5$	1												
$1.5 < d$	0												
4	Scratch	In accordance with spots and lines operating cosmetic criteria. When the light reflects on the panel surface, the scratches are not to be remarkable.	Minor										
5	Allowable density	Above defects should be separated more than 30mm each other.	Minor										
6	Coloration	Not to be noticeable coloration in the viewing area of the LCD panels. Back-lit type should be judged with back-lit on state only.	Minor										
7	Contamination	Not to be noticeable.	Minor										

OUTGOING QUALITY STANDARD	P.4 of 5
TITLE:FUNCTIONAL TEST & INSPECTION CRITERIA	Normal LCM Product

### 4. 2. 3 Cosmetic Criteria (Operating)

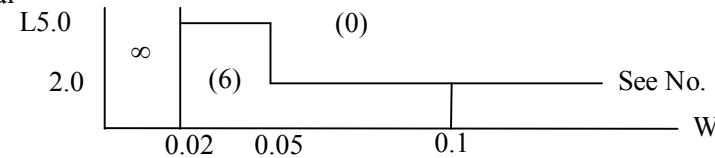
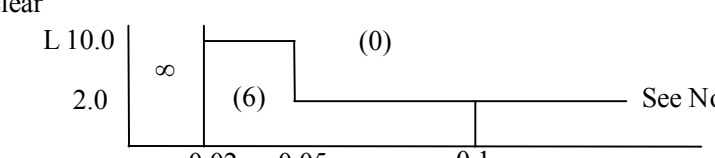
No.	Defect	Judgment Criterion	Partition																																												
1	Spots	A) I Clear <table border="1" style="margin-top: 10px;"> <thead> <tr> <th>Lcd size</th> <th>Size : d mm</th> <th>Acceptable Qty in active area</th> </tr> </thead> <tbody> <tr> <td rowspan="4" style="text-align: center;">Lcd size ≤ 8.0'</td> <td>d ≤ 0.1</td> <td style="text-align: center;">Disregard</td> </tr> <tr> <td>0.1 &lt; d ≤ 0.2</td> <td style="text-align: center;">6</td> </tr> <tr> <td>0.2 &lt; d ≤ 0.3</td> <td style="text-align: center;">2</td> </tr> <tr> <td>0.3 &lt; d</td> <td style="text-align: center;">0</td> </tr> <tr> <td rowspan="4" style="text-align: center;">Lcd size &gt; 8.0'</td> <td>d ≤ 0.1</td> <td style="text-align: center;">Disregard</td> </tr> <tr> <td>0.1 &lt; d ≤ 0.3</td> <td style="text-align: center;">10</td> </tr> <tr> <td>0.3 &lt; d ≤ 0.5</td> <td style="text-align: center;">5</td> </tr> <tr> <td>0.5 &lt; d</td> <td style="text-align: center;">0</td> </tr> </tbody> </table> <p style="margin-top: 10px;">Note : Including pin holes and defective dots which must be within one pixel size; Total defective point shall not exceed 6 pcs no more than 8 inch LCD and 10PCS for more than 8 inch LCD.</p> B) Unclear <table border="1" style="margin-top: 10px;"> <thead> <tr> <th>Lcd size</th> <th>Size : d mm</th> <th>Acceptable Qty in active area</th> </tr> </thead> <tbody> <tr> <td rowspan="4" style="text-align: center;">Lcd size ≤ 8.0'</td> <td>d ≤ 0.2</td> <td style="text-align: center;">Disregard</td> </tr> <tr> <td>0.2 &lt; d ≤ 0.5</td> <td style="text-align: center;">6</td> </tr> <tr> <td>0.5 &lt; d ≤ 0.7</td> <td style="text-align: center;">2</td> </tr> <tr> <td>0.7 &lt; d</td> <td style="text-align: center;">0</td> </tr> <tr> <td rowspan="4" style="text-align: center;">Lcd size &gt; 8.0'</td> <td>d ≤ 0.2</td> <td style="text-align: center;">Disregard</td> </tr> <tr> <td>0.2 &lt; d ≤ 0.5</td> <td style="text-align: center;">10</td> </tr> <tr> <td>0.5 &lt; d ≤ 0.7</td> <td style="text-align: center;">3</td> </tr> <tr> <td>0.7 &lt; d ≤ 1.0</td> <td style="text-align: center;">1</td> </tr> <tr> <td>1.0 &lt; d</td> <td style="text-align: center;">0</td> </tr> </tbody> </table> <p style="margin-top: 10px;">Note : Total defective point shall not exceed 6 pcs for no more than 8 inch LCD and 10PCS for more than 8 inch LCD.</p>	Lcd size	Size : d mm	Acceptable Qty in active area	Lcd size ≤ 8.0'	d ≤ 0.1	Disregard	0.1 < d ≤ 0.2	6	0.2 < d ≤ 0.3	2	0.3 < d	0	Lcd size > 8.0'	d ≤ 0.1	Disregard	0.1 < d ≤ 0.3	10	0.3 < d ≤ 0.5	5	0.5 < d	0	Lcd size	Size : d mm	Acceptable Qty in active area	Lcd size ≤ 8.0'	d ≤ 0.2	Disregard	0.2 < d ≤ 0.5	6	0.5 < d ≤ 0.7	2	0.7 < d	0	Lcd size > 8.0'	d ≤ 0.2	Disregard	0.2 < d ≤ 0.5	10	0.5 < d ≤ 0.7	3	0.7 < d ≤ 1.0	1	1.0 < d	0	Minor
Lcd size	Size : d mm	Acceptable Qty in active area																																													
Lcd size ≤ 8.0'	d ≤ 0.1	Disregard																																													
	0.1 < d ≤ 0.2	6																																													
	0.2 < d ≤ 0.3	2																																													
	0.3 < d	0																																													
Lcd size > 8.0'	d ≤ 0.1	Disregard																																													
	0.1 < d ≤ 0.3	10																																													
	0.3 < d ≤ 0.5	5																																													
	0.5 < d	0																																													
Lcd size	Size : d mm	Acceptable Qty in active area																																													
Lcd size ≤ 8.0'	d ≤ 0.2	Disregard																																													
	0.2 < d ≤ 0.5	6																																													
	0.5 < d ≤ 0.7	2																																													
	0.7 < d	0																																													
Lcd size > 8.0'	d ≤ 0.2	Disregard																																													
	0.2 < d ≤ 0.5	10																																													
	0.5 < d ≤ 0.7	3																																													
	0.7 < d ≤ 1.0	1																																													
1.0 < d	0																																														
2	Lines	A) Clear  <p style="margin-top: 10px;">Note : ( ) - Acceptable Qty in active area L - Length (mm) W - Width (mm) ∞ - Disregard</p> B) Unclear  <p style="margin-top: 10px;">‘Clear’ = The shade and size are not changed by V<sub>op</sub>. ‘Unclear’ = The shade and size are changed by V<sub>op</sub>.</p>	Minor																																												

 OUTGOING QUALITY STANDARD			P.5 of 5
TITLE:FUNCTIONAL TEST & INSPECTION CRITERIA			Normal LCM Product
3	Rubbing line	Not to be noticeable.	Minor
4	Allowable density	Above defects should be separated more than 10mm each other.	Minor
5	Rainbow	Not to be noticeable.	Minor
6	Dot size	To be 95% ~ 105% of the dot size (Typ.) in drawing. Partial defects of each dot (ex. pin-hole) should be treated as 'Spot'. (see <i>Screen Cosmetic Criteria (Operating) No.1</i> )	Minor
7	Uneven brightness (only back-lit type module)	Uneven brightness must be $B_{MAX} / B_{MIN} \leq 2$ - $B_{MAX}$ : Max. value by measure in 5 points - $B_{MIN}$ : Min. value by measure in 5 points Divide active area into 4 vertically and horizontally. Measure 5 points shown in the following figure.	Minor

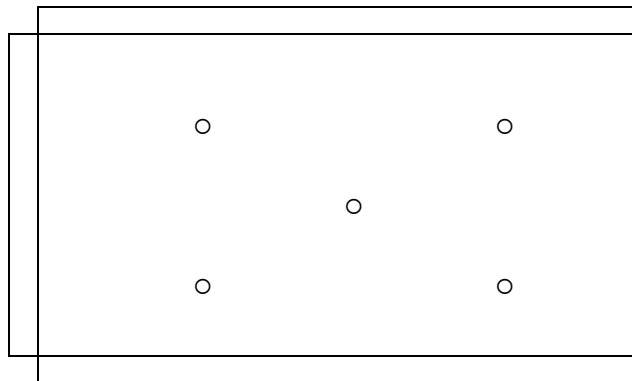

○ : Measuring points

Note :

- (1) Size :  $d = (\text{long length} + \text{short length}) / 2$
- (2) The limit samples for each item have priority.
- (3) Complex defects are defined item by item, but if the numbers of defects are defined in above table, the total number should not exceed 10.
- (4) In case of 'concentration', even the spots or the lines of 'disregarded' size should not allowed. Following three situations should be treated as 'concentration'.
  - 7 or over defects in circle of  $\varnothing 5\text{mm}$ .
  - 10 or over defects in circle of  $\varnothing 10\text{mm}$ .
  - 20 or over defects in circle of  $\varnothing 20\text{mm}$ .

## ■ PRECAUTIONS FOR USING LCD MODULES

### Handing Precautions

(1) The display panel is made of glass and polarizer. As glass is fragile. It tends to become or chipped during handling especially on the edges. Please avoid dropping or jarring. Do not subject it to a mechanical shock by dropping it or impact.

(2) If the display panel is damaged and the liquid crystal substance leaks out, be sure not to get any in your mouth. If the substance contacts your skin or clothes, wash it off using soap and water.

(3) Do not apply excessive force to the display surface or the adjoining areas since this may cause the color tone to vary. Do not touch the display with bare hands. This will stain the display area and degraded insulation between terminals (some cosmetics are determined to the polarizer).

(4) The polarizer covering the display surface of the LCD module is soft and easily scratched. Handle this polarizer carefully. Do not touch, push or rub the exposed polarizers with anything harder than an HB pencil lead (glass, tweezers, etc.). Do not put or attach anything on the display area to avoid leaving marks on. Condensation on the surface and contact with terminals due to cold will damage, stain or dirty the polarizer. After products are tested at low temperature they must be warmed up in a container before coming is contacting with room temperature air.

(5) If the display surface becomes contaminated, breathe on the surface and gently wipe it with a soft dry cloth. If it is heavily contaminated, moisten cloth with one of the following solvents

- Isopropyl alcohol
- Ethyl alcohol

Do not scrub hard to avoid damaging the display surface.

(6) Solvents other than those above-mentioned may damage the polarizer. Especially, do not use the following.

- Water
- Ketone
- Aromatic solvents

Wipe off saliva or water drops immediately, contact with water over a long period of time may cause deformation or color fading. Avoid contacting oil and fats.

(7) Exercise care to minimize corrosion of the electrode. Corrosion of the electrodes is accelerated by water droplets, moisture condensation or a current flow in a high-humidity environment.

(8) Install the LCD Module by using the mounting holes. When mounting the LCD module make sure it is free of twisting, warping and distortion. In particular, do not forcibly pull or bend the I/O cable or the backlight cable.

(9) Do not attempt to disassemble or process the LCD module.

(10) NC terminal should be open. Do not connect anything.

(11) If the logic circuit power is off, do not apply the input signals.

(12) Electro-Static Discharge Control, Since this module uses a CMOS LSI, the same careful attention should be paid to electrostatic discharge as for an ordinary CMOS IC. To prevent destruction of the elements by static electricity, be careful to maintain an optimum work environment.

- Before remove LCM from its packing case or incorporating it into a set, be sure the module and your body have the same electric potential. Be sure to ground the body when handling the LCD modules.

- Tools required for assembling, such as soldering irons, must be properly grounded. make certain the AC power source for the soldering iron does not leak. When using an electric screwdriver to attach LCM, the screwdriver should be of ground potentiality to minimize as much as possible any transmission of electromagnetic waves produced sparks coming from the commutator of the motor.

- To reduce the amount of static electricity generated, do not conduct assembling and other work under dry conditions. To reduce the generation of static electricity be careful that the air in the work is not too dried. A relative humidity of 50%-60% is recommended. As far as possible make the electric potential of your work clothes and that of the work bench the ground potential

- The LCD module is coated with a film to protect the display surface. Exercise care when peeling off this protective film since static electricity may be generated

(13) Since LCM has been assembled and adjusted with a high degree of precision, avoid applying excessive shocks to the module or making any alterations or modifications to it.

- Do not alter, modify or change the shape of the tab on the metal frame.

- Do not make extra holes on the printed circuit board, modify its shape or change the positions of components to be attached.

- Do not damage or modify the pattern writing on the printed circuit board.

- Absolutely do not modify the zebra rubber strip (conductive rubber) or heat seal connector.

- Except for soldering the interface, do not make any alterations or modifications with a soldering iron.

- Do not drop, bend or twist LCM.



**Handling precaution for LCM**

LCM is easy to be damaged. Please note below and be careful for handling.

**Correct handling:**

As above picture, please handle with anti-static gloves around LCM edges.

**Incorrect handling:**

Please don't touch IC directly.

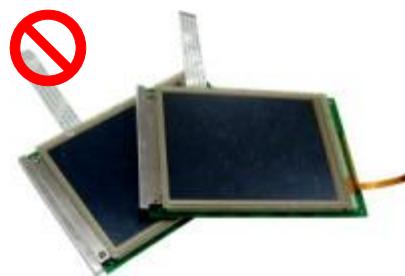

Please don't stack LCM.



Please don't hold the surface of panel.

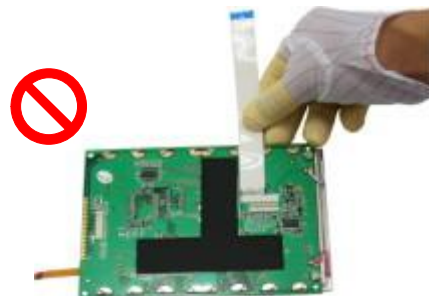

Please don't stretch interface of output, such as FPC cable.

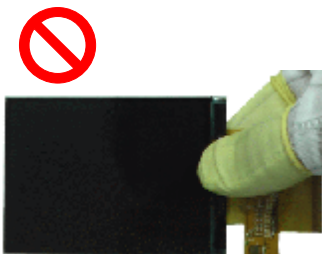

Please don't hold the surface of IC.



Please don't operate with sharp stick such as pens.

**Storage Precautions**

When storing the LCD modules, the following precaution is necessary.

- (1) Store them in a sealed polyethylene bag. If properly sealed, there is no need for the dessicant.
- (2) Store them in a dark place. Do not expose to sunlight or fluorescent light, keep the temperature between 0°C and 35°C, and keep the relative humidity between 40%RH and 60%RH.
- (3) The polarizer surface should not come in contact with any other objects. (We advise you to store them in the anti-static electricity container in which they were shipped.

**Others**

Liquid crystals solidify under low temperature (below the storage temperature range) leading to defective orientation or the generation of air bubbles (black or white). Air bubbles may also be generated if the module is subject to a low temperature.

If the LCD modules have been operating for a long time showing the same display patterns, the display patterns may remain on the screen as ghost images and a slight contrast irregularity may also appear. A normal operating status can be regained by suspending use for some time. It should be noted that this phenomenon does not adversely affect performance reliability.

To minimize the performance degradation of the LCD modules resulting from destruction caused by static electricity etc., exercise care to avoid holding the following sections when handling the modules.

- Exposed area of the printed circuit board.
- Terminal electrode sections.

**■ USING LCD MODULES**

**Installing LCD Modules**

The hole in the printed circuit board is used to fix LCM as shown in the picture below. Attend to the following items when installing the LCM.

- (1) Cover the surface with a transparent protective plate to protect the polarizer and LC cell.

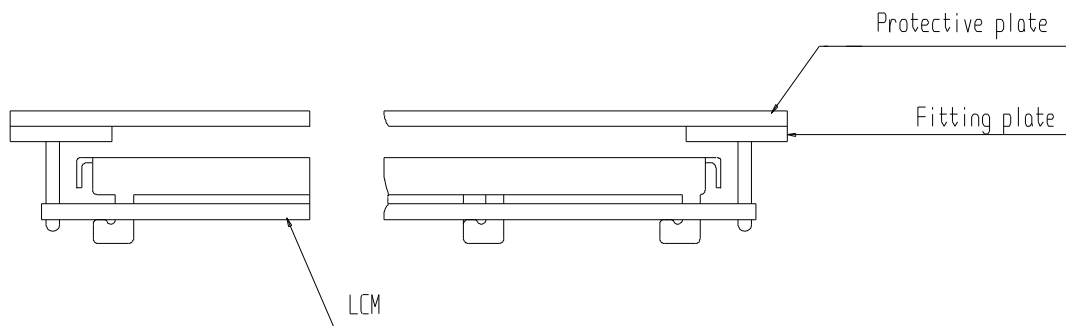

- (2) When assembling the LCM into other equipment, the spacer to the bit between the LCM and the fitting plate should have enough height to avoid causing stress to the module surface, refer to the individual specifications for measurements. The measurement tolerance should be ±0.1 mm.

**Precaution for assemble the module with BTB connector:**

Please note the position of the male and female connector position, don't assemble or assemble like the method which the following picture shows

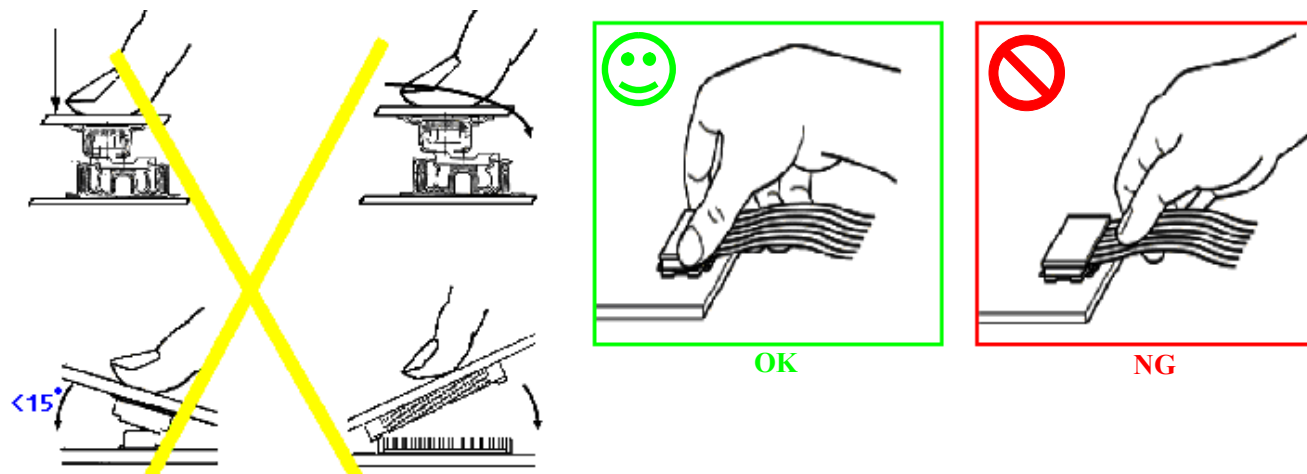

**Precaution for soldering the LCM**

	<b>Manual soldering</b>	<b>Machine drag soldering</b>	<b>Machine press soldering</b>
<b>No ROHS product</b>	290°C ~350°C. Time : 3-5S.	330°C ~350°C. Speed : 4-8 mm/s.	300°C ~330°C. Time : 3-6S. Press: 0.8~1.2Mpa
<b>ROHS product</b>	340°C ~370°C. Time : 3-5S.	350°C ~370°C. Time : 4-8 mm/s.	330°C ~360°C. Time : 3-6S. Press: 0.8~1.2Mpa

(1) If soldering flux is used, be sure to remove any remaining flux after finishing to soldering operation. (This does not apply in the case of a non-halogen type of flux.) It is recommended that you protect the LCD surface with a cover during soldering to prevent any damage due to flux spatters.

(2) When soldering the electroluminescent panel and PC board, the panel and board should not be detached more than three times. This maximum number is determined by the temperature and time conditions mentioned above, though there may be some variance depending on the temperature of the soldering iron.

(3) When remove the electroluminescent panel from the PC board, be sure the solder has completely melted, the soldered pad on the PC board could be damaged.

**Precautions for Operation**

(1) Viewing angle varies with the change of liquid crystal driving voltage (VLCD). Adjust VLCD to show the best contrast.

(2) It is an indispensable condition to drive LCD's within the specified voltage limit since the higher voltage than the limit cause the shorter LCD life. An electrochemical reaction due to direct current causes LCD's undesirable deterioration, so that the use of direct current drive should be avoided.

(3) Response time will be extremely delayed at lower temperature than the operating temperature range and on the other hand at higher temperature LCD's show dark color in them. However those phenomena do not mean malfunction or out of order with LCD's, Which will come back in the specified operating temperature.

(4) If the display area is pushed hard during operation, the display will become abnormal. However, it will return to normal if it is turned off and then back on.

(5) A slight dew depositing on terminals is a cause for electro-chemical reaction resulting in terminal open circuit. Usage under the maximum operating temperature, 50%RH or less is required.

(6) Input logic voltage before apply analog high voltage such as LCD driving voltage when power on. Remove analog high voltage before logic voltage when power off the module. Input each signal after the positive/negative voltage becomes stable.

(7) Please keep the temperature within specified range for use and storage. Polarization degradation, bubble generation or polarizer peel-off may occur with high temperature and high humidity.

**Safety**

(1) It is recommended to crush damaged or unnecessary LCDs into pieces and wash them off with solvents such as acetone and ethanol, which should later be burned.

(2) If any liquid leaks out of a damaged glass cell and comes in contact with the hands, wash off thoroughly with soap and water.

**Limited Warranty**

Unless agreed between TRULY and customer, TRULY will replace or repair any of its LCD modules which are found to be functionally defective when inspected in accordance with TRULY LCD acceptance standards (copies available upon request) for a period of one year from date of production. Cosmetic/visual defects must be returned to TRULY within 90 days of shipment. Confirmation of such date shall be based on data code on product. The warranty liability of TRULY limited to repair and/or replacement on the terms set forth above. TRULY will not be responsible for any subsequent or consequential events.

**Return LCM under warranty**

No warranty can be granted if the precautions stated above have been disregarded. The typical examples of violations are :

- Broken LCD glass.
- PCB eyelet is damaged or modified.
- PCB conductors damaged.
- Circuit modified in any way, including addition of components.
- PCB tampered with by grinding, engraving or painting varnish.
- Soldering to or modifying the bezel in any manner.

Module repairs will be invoiced to the customer upon mutual agreement. Modules must be returned with sufficient description of the failures or defects. Any connectors or cable installed by the customer must be removed completely without damaging the PCB eyelet, conductors and terminals.

## ■ PRIOR CONSULT MATTER

- 1.①For Truly standard products, we keep the right to change material, process ... for improving the product property without notice on our customer.
- ②For OEM products, if any change needed which may affect the product property, we will consult with our customer in advance.
- 2.If you have special requirement about reliability condition, please let us know before you start the test on our samples.

## ■ FACTORY CONTACT INFORMATION

**FACTORY NAME:** TRULY SEMICONDUCTORS LTD.

**FACTORY ADDRESS:** Truly Industrial Area, ShanWei City,GuangDong,China

**P.C:** 516600 **URL:** <http://www.truly.com.hk> <http://www.trulysemi.com>