

SPECIFICATION

PART NO. : OEL9M0085-Y-E

OLED
Display
128X64

0.96"

This specification maybe changed without any notice in order to improve performance or quality etc.

Please contact TRULY Semiconductors LTD. OLED R&D department for update specification and product status before design for this product or release the order.

PRODUCT CONTENTS

- PHYSICAL DATA
- ABSOLUTE MAXIMUM RATINGS
- EXTERNAL DIMENSIONS
- ELECTRICAL CHARACTERISTICS
- ELECTRO-OPTICAL CHARACTERISTICS
- INTERFACE PIN CONNECTIONS
- COMMAND TABLE
- INITIALIZATION CODE
- SCHEMATIC EXAMPLE
- RELIABILITY TESTS
- OUTGOING QUALITY CONTROL SPECIFICATION
- CAUTIONS IN USING OLED MODULE

TRULY®信利		Customer	
Written by	ZhangJingang	Approved by	
Checked by	LiLiumin		
Approved by	ZhangWeicang		

REVISION HISTORY

Rev.	Contents	Date
0.1	Preliminary	2012-08-25

■ PHYSICAL DATA

No.	Items:	Specification:	Unit
1	Diagonal Size	0.96	Inch
2	Resolution	128(H) x 64(V)	Dots
3	Active Area	21.740(W) x 11.175(H)	mm ²
4	Outline Dimension (Panel)	26.70(W) x 19.26(H)	mm ²
5	Pixel Pitch	0.170(W) x 0.175(H)	mm ²
6	Pixel Size	0.150(W) x 0.150(H)	mm ²
7	Driver IC	SH1106G	-
8	Display Color	Yellow	-
9	Grayscale	1	Bit
10	Interface	4-wire Serial	-
11	IC package type	COG	-
12	Thickness	1.45±0.1	mm
13	Weight	TBD	g
14	Duty	1/64	-

■ ABSOLUTE MAXIMUM RATINGS

 Unless otherwise specified,(Voltage Referenced to V_{SS})

(Ta = 25°C)

Items		Symbol	Min	Typ.	Max	Unit
Supply Voltage	Logic	V _{DD1}	-0.3	-	3.6	V
	Logic	V _{DD2}	-0.3	-	4.3	V
	Driving	V _{PP}	-0.3	-	13.5	V
Operating Temperature		Top	-20	-	70	°C
Storage Temperature		Tst	-30	-	80	°C
Humidity		-	-	-	90	%RH

NOTE:

Permanent device damage may occur if ABSOLUTE MAXIMUM RATINGS are exceeded.

Functional operation should be restricted to the conditions as detailed in the operational sections of this data sheet. Exposure to absolute maximum rating conditions for extended periods may affect reliability.

■ ELECTRICAL CHARACTERISTICS

◆ DC Characteristics

Condition(Unless otherwise specified):

Voltage referenced to V_{SS}

$V_{DD}=1.65V$ to $3.5V$

$T_a = 25^{\circ}C$

Items		Symbol	Min	Typ.	Max	Unit
Supply Voltage	Logic	V_{DD1}	1.65	-	3.5	V
	Charge Pump Regulator Supply Voltage	V_{DD2}	3.0	-	4.2	V
	Operating	V_{CC}	6.4	-	13.0	V
Input Voltage	High Voltage	V_{IH}	$0.8 \times V_{DD1}$	-	V_{DD1}	V
	Low Voltage	V_{IL}	V_{SS}	-	$0.2 \times V_{DD1}$	V
Output Voltage	High Voltage	V_{OH}	$0.8 \times V_{DD1}$	-	V_{DD1}	V
	Low Voltage	V_{OL}	V_{SS}	-	$0.2 \times V_{DD1}$	V

◆ AC Characteristics

1. 4-wire Serial Interface Timing Characteristics
($V_{DD} - V_{SS} = 1.65V$ to $3.3V$, $T_A = 25^\circ C$)

Symbol	Parameter	Min.	Typ.	Max.	Unit	Condition
tscyc	Serial clock cycle	500	-	-	ns	
tsAS	Address setup time	300	-	-	ns	
tSAH	Address hold time	300	-	-	ns	
tSDS	Data setup time	200	-	-	ns	
tSDH	Data hold time	200	-	-	ns	
tcSS	\overline{CS} setup time	240	-	-	ns	
tCSH	\overline{CS} hold time	120	-	-	ns	
tSHW	Serial clock H pulse width	200	-	-	ns	
tSLW	Serial clock L pulse width	200	-	-	ns	
tR	Rise time	-	-	30	ns	
tF	Fall time	-	-	30	ns	

4-wire Serial interface characteristics

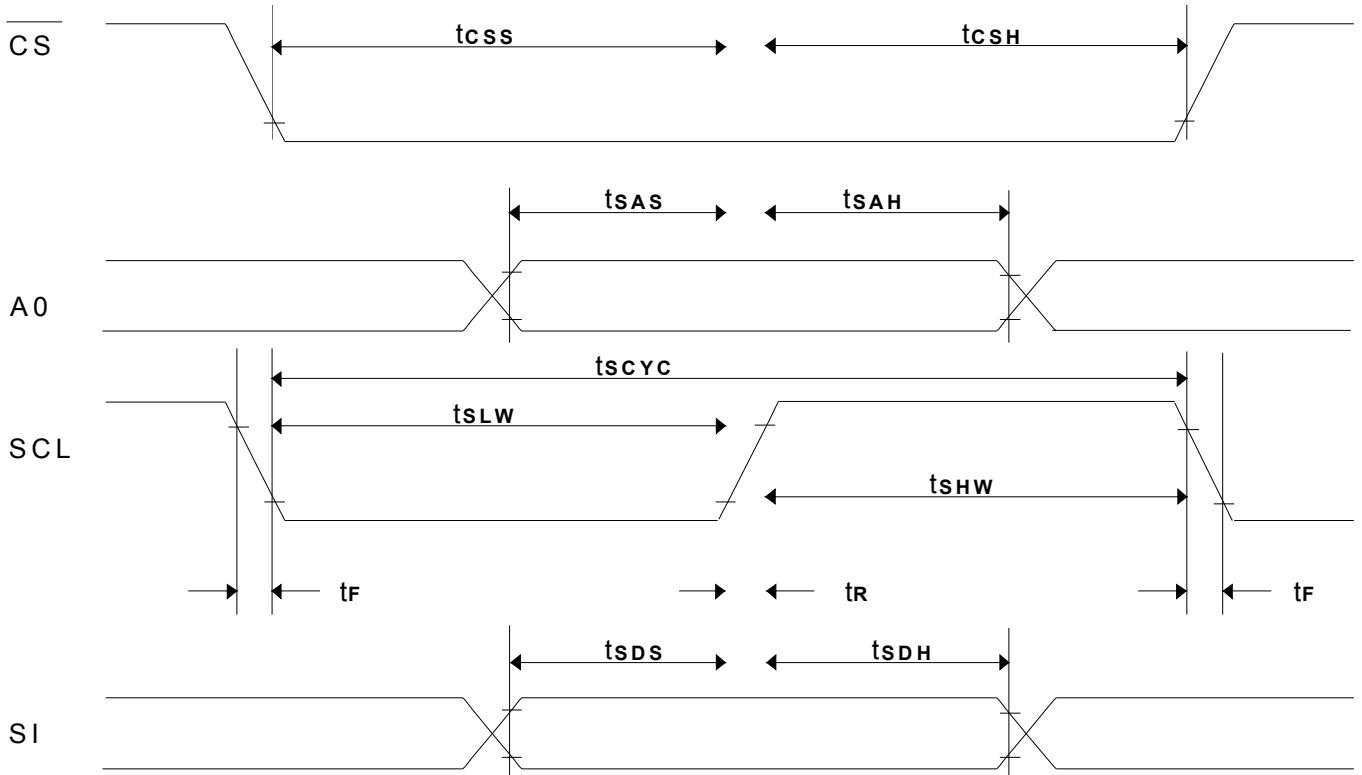

■ **ELECTRO-OPTICAL CHARACTERISTICS (Ta=25°C)**

Items		Symbol	Min.	Typ.	Max.	Unit	Remark
Operating Luminance	L		TBD	TBD	-	cd /m ²	VPP generated by internal charge pump
			65	80	-		VPP Supply Externally
Power Consumption	P		-	TBD	TBD	mW	30% pixels ON internal DC/DC
			-	25	40		30% pixels ON Externally VPP
Frame Frequency		Fr	-	100	-	Hz	-
Color Coordinate	Blue	CIE x	0.42	0.46	0.50	CIE1931	Darkroom
		CIE y	0.47	0.51	0.55		
Response Time	Rise	Tr	-	-	0.02	ms	-
	Decay	Td	-	-	0.02	ms	-
Contrast Ratio*		Cr	10000:1	-	-	-	Darkroom
Viewing Angle Uniformity		△ θ	160	-	-	Degree	-
Operating Life Time*		Top	20,000	-	-	Hours	L ₀ =80cd/m ²

Driving condition:

1. Internal Charge pump(VPP Generated by Charge pump):

Test condition:TBD.

2. VPP Supplied Externally

Driving voltage : VDD1=3.0V, VPP=9.0V, VDD2:NC or connect VDD1.

Contrast setting :0x40;

Note:

1. Contrast ratio is defined as follows:

$$\text{Contrast ratio} = \frac{\text{Photo - detector output with OLED being "white"}}{\text{Photo - detector output with OLED being "black"}}$$

2. Life Time is defined when the Luminance has decayed to less than 50% of the initial Luminance specification. (Odd and even chess board alternately displayed) (The initial value should be closed to the typical value after adjusting.)

■ INTERFACE PIN CONNECTIONS

No	Symbol	Description
1	C1P	Connect to charge pump capacitor. These pins are not used and should be disconnected when Vpp is supplied externally.
2	C1N	
3	C2P	
4	C2N	
5	VDD2	3.0 – 4.2V power supply pad for Power supply for charge pump circuit.
6	VSS	This is a ground pin
7	VDD1	Power supply input: 1.65 - 3.5V
8	CSB	This is the chip select input.(active LOW)
9	RESB	This is a reset signal input pad. When RES is set to “L”, the settings are initialized. The reset operation is performed by the RES signal level.
10	A0	This is the Data/Command control pad that determines whether the data bits are data or a command.
11	SCL	serial clock input pad
12	SI	Serial data input pad
13	IREF	This is a segment current reference pad. A resistor should be connected between this pad and VSS. Set the current at 10μA.
14	VOMH	This is a pad for the voltage output high level for common signals. A capacitor should be connected between this pad and VSS.
15	VPP	Power supply for panel driving voltage. This is also the most positive power voltage supply pin. When charge pump is enabled, a capacitor should be connected between this pin and VSS.

Status	VBAT(VDD2)	VDD(VDD1)	VPP
Enable Charge pump	Connect to external VBAT source	Connect to external VDD source	A capacitor should be connected between this pin and VSS
Disable Charge pump	Keep float	Connect to external VDD source	Connect to external VPP source

■ COMMAND TABLE

Command	Code											Function
	A0	\overline{RD}	\overline{WR}	D7	D6	D5	D4	D3	D2	D1	D0	
1. Set Column Address 4 lower bits	0	1	0	0	0	0	0	Lower column address				Sets 4 lower bits of column address of display RAM in register. (POR = 00H)
2. Set Column Address 4 higher bits	0	1	0	0	0	0	1	Higher column address				Sets 4 higher bits of column address of display RAM in register. (POR = 10H)
3. Set Pump voltage value	0	1	0	0	0	1	1	0	0	Pump voltage value	This command is to control the DC-DC voltage output value. (POR=32H)	
4. Set Display Start Line	0	1	0	0	1	Line address					Specifies RAM display line for COM0. (POR = 40H)	
5. The Contrast Control Mode Set	0	1	0	1	0	0	0	0	0	0	1	This command is to set Contrast Setting of the display. The chip has 256 contrast steps from 00 to FF. (POR = 80H)
Contrast Data Register Set	0	1	0	Contrast Data								
6. Set Segment Re-map (ADC)	0	1	0	1	0	1	0	0	0	0	ADC	The right (0) or left (1) rotation. (POR = A0H)
7. Set Entire Display OFF/ON	0	1	0	1	0	1	0	0	1	0	D	Selects normal display (0) or Entire Display ON (1). (POR = A4H)
8. Set Normal/Reverse Display	0	1	0	1	0	1	0	0	1	1	D	Normal indication (0) when low, but reverse indication (1) when high. (POR = A6H)
9 Multiplex Ration Mode Set	0	1	0	1	0	1	0	1	0	0	0	This command switches default 63 multiplex mode to any multiplex ratio from 1 to 64. (POR = 3FH)
Multiplex Ration Data Set	0	1	0	*	*	Multiplex Ratio						
10. DC-DC Control Mode Set	0	1	0	1	0	1	0	1	1	0	1	This command is to control the DC-DC voltage DC-DC will be turned on when display on converter (1) or DC-DC OFF (0). (POR = 8BH)
DC-DC ON/OFF Mode Set	0	1	0	1	0	0	0	1	0	1	D	

Command	Code											Function
	A0	\overline{RD}	\overline{WR}	D7	D6	D5	D4	D3	D2	D1	D0	
11. Display OFF/ON	0	1	0	1	0	1	0	1	1	1	D	Turns on OLED panel (1) or turns off (0). (POR = AEH)
12. Set Page Address	0	1	0	1	0	1	1	Page Address				Specifies page address to load display RAM data to page address register. (POR = B0H)
13. Set Common Output Scan Direction	0	1	0	1	1	0	0	D	*	*	*	Scan from COM0 to COM [N - 1] (0) or Scan from COM [N - 1] to COM0 (1). (POR = C0H)
14. Display Offset Mode Set	0	1	0	1	1	0	1	0	0	1	1	This is a double byte command which specifies the mapping of display start line to one of COM0-63. (POR = 00H)
Display Offset Data Set	0	1	0	*	*	COMx						
15. Set Display Divide Ratio/Oscillator Frequency Mode Set	0	1	0	1	1	0	1	0	1	0	1	This command is used to set the frequency of the internal display clocks. (POR = 50H)
Divide Ratio/Oscillator Frequency Data Set	0	1	0	Oscillator Frequency				Divide Ratio				
16. Dis-charge / Pre-charge Period Mode Set	0	1	0	1	1	0	1	1	0	0	1	This command is used to set the duration of the dis-charge and pre-charge period. (POR = 22H)
Dis-charge /Pre-charge Period Data Set	0	1	0	Dis-charge Period				Pre-charge Period				
17. Common Pads Hardware Configuration Mode Set	0	1	0	1	1	0	1	1	0	1	0	This command is to set the common signals pad configuration. (POR = 12H)
Sequential/Alternative Mode Set	0	1	0	0	0	0	D	0	0	1	0	
18. VCOM Deselect Level Mode Set	0	1	0	1	1	0	1	1	0	1	1	This command is to set the common pad output voltage level at deselect stage. (POR = 35H)
VCOM Deselect Level Data Set	0	1	0	VCOM ($\beta \times V_{REF}$)								
19. Read-Modify-Write	0	1	0	1	1	1	0	0	0	0	0	Read-Modify-Write start.
20. End	0	1	0	1	1	1	0	1	1	1	0	Read-Modify-Write end.
21. NOP	0	1	0	1	1	1	0	0	0	1	1	Non-Operation Command
22. Write Display Data	1	1	0	Write RAM data								
23. Read Status	0	0	1	BUSY	ON/OFF	*	*	*	0	0	0	
24. Read Display Data	1	0	1	Read RAM data								

■ INITIALIZATION CODE**void InitOLED_MASTER_SH1106G(void)**

```
{  
    MainOLED_WCom(0xAE);    //DOT MARTIX DISPLAY OFF  
  
    MainOLED_WCom(0x33);    //SET PUMP VOLTAGE 9v  
  
    MainOLED_WCom(0x40);    //SET DISPLAY START LINE(40H-7FH)  
  
    MainOLED_WCom(0x81);    //CONTARST CONTROL(00H-0FFH)  
    MainOLED_WCom(0X40);  
  
    MainOLED_WCom(0xA1);    //SET SEGMENT RE-MAP(0A0H-0A1H)  
    MainOLED_WCom(0xA4);    //ENTIRE DISPLAY OFF(0A4H-0A5H)  
    MainOLED_WCom(0xA6);    //SET NORMAL DISPLAY(0A6H-0A7H)  
  
    MainOLED_WCom(0xA8);    //SET MULTIPLEX RATIO 64  
    MainOLED_WCom(0x3F);  
  
    MainOLED_WCom(0xAD);    //SET DC/DC BOOSTER(8AH=OFF,8BH=ON)  
    MainOLED_WCom(0x8B);  
  
    MainOLED_WCom(0xC8);    //COM SCAN COM1-COM64(0C8H,0C0H)  
  
    MainOLED_WCom(0xD3);    //SET DISPLAY OFFSET(OOH-3FH)  
    MainOLED_WCom(0x00);  
  
    MainOLED_WCom(0xD5);    //SET FRAME FREQUENCY  
    MainOLED_WCom(0x80);  
  
    MainOLED_WCom(0xD9);    //SET PRE_CHARGE PERIOD  
    MainOLED_WCom(0x1F);  
  
    MainOLED_WCom(0xDA);    //COM PIN CONFIGURATION(02H,12H)  
    MainOLED_WCom(0x12);  
  
    MainOLED_WCom(0xDB);    //SET VCOM DESELECT LEVEL(35H)  
    MainOLED_WCom(0x40);  
  
    Delayms(100);  
    MainOLED_WCom(0xAF);    //DSPLAY ON  
}
```

■ SCHEMATIC EXAMPLE

◆ Serial Interface Application Circuit(Internal Charge Pump):

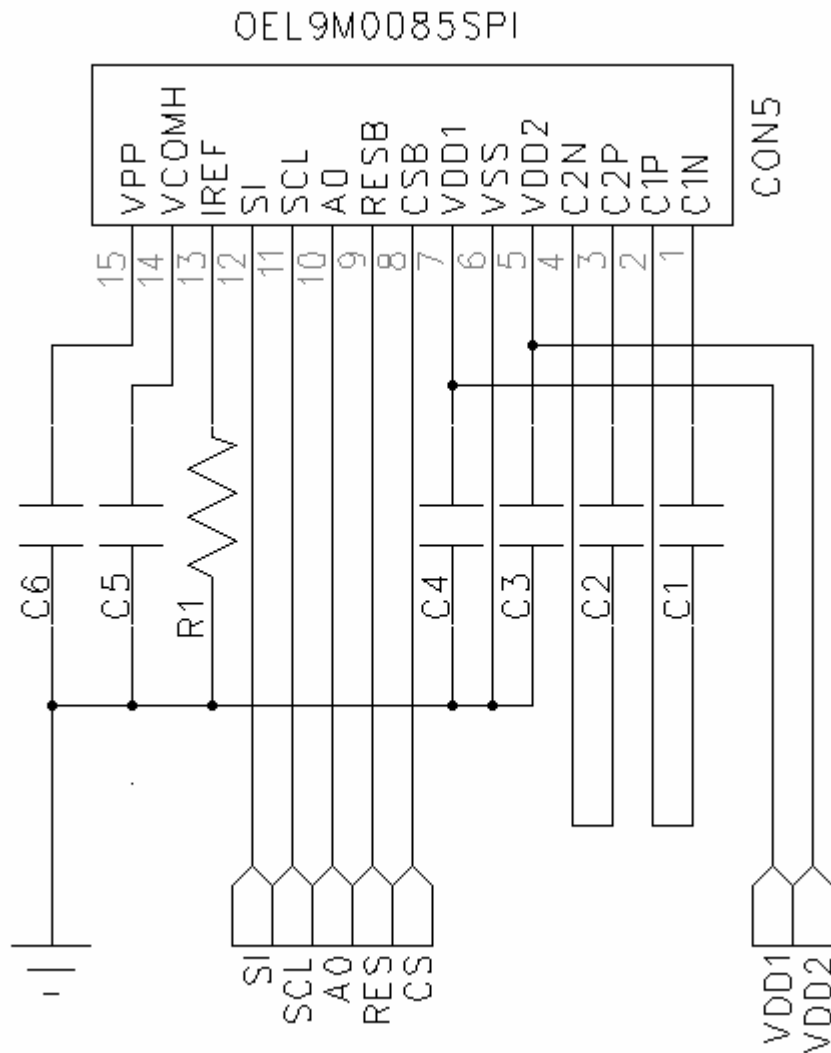

NOTE:

1. $R1 = (\text{Voltage at IREF} - VSS) / IREF \approx 510K\Omega$, $C1 = C2 = 1.0\mu F$,
 $C3 = C4 = C5 = C6 = 4.7\mu F$;
2. The V_{DD1} V_{DD2} should connect external voltage;
3. In the Serial interface mode, read function is not possible.

■ **RELIABILITY TESTS**

Item		Condition	Criterion
High Temperature Storage (HTS)		85±2°C, 200 hours	<ol style="list-style-type: none"> 1. After testing, the function test is ok. 2. After testing, no addition to the defect. 3. After testing, the change of luminance should be within +/- 50% of initial value. 4. After testing, the change for the mono and area color must be within (+/-0.02, +/-0.02) and for the full color it must be within (+/-0.04, +/-0.04) of initial value based on 1931 CIE coordinates. 5. After testing, the change of total current consumption should be within +/- 50% of initial value.
High Temperature Operating (HTO)		70±2°C, 96 hours	
Low Temperature Storage (LTS)		-40±2°C, 200 hours	
Low Temperature Operating (LTO)		-40±2°C, 96 hours	
High Temperature / High Humidity Storage (HTHHS)		50±3°C, 90%±3%RH, 120 hours	
Thermal Shock (Non-operation) (TS)		-40±2°C ~ 25°C ~ 70±2°C (30min) (5min) (30min) 10cycles	
Vibration (Packing)	10~55~10Hz, amplitude 1.5mm, 1 hour for each direction x, y, z	<ol style="list-style-type: none"> 1. One box for each test. 2. No addition to the cosmetic and the electrical defects. 	
Drop (Packing)	Height : 1 m, each time for 6 sides, 3 edges, 1 angle		
ESD (finished product housing)	±4kV (R: 330Ω C: 150pF, 10times, air discharge)		<ol style="list-style-type: none"> 1. After testing, cosmetic and electrical defects should not happen. 2. In case of malfunction or defect caused by ESD damage, it would be judged as a good part if it would be recovered to normal state after resetting.

- Note:**
- 1) For each reliability test, the sample quantity is 3, and only for one test item.
 - 2) The HTHHS test is requested the Pure Water(Resistance>10MΩ).
 - 3) The test should be done after 2 hours of recovery time in normal environment.

■ OUTGOING QUALITY CONTROL SPECIFICATION

◆ Standard

According to GB/T2828.1-2003/ISO 2859-1: 1999 and ANSI/ASQC Z1.4-1993, General Inspection Level II.

◆ Definition

- 1 Major defect : The defect that greatly affect the usability of product.
- 2 Minor defect : The other defects, such as cosmetic defects, etc.
- 3 Definition of inspection zone:

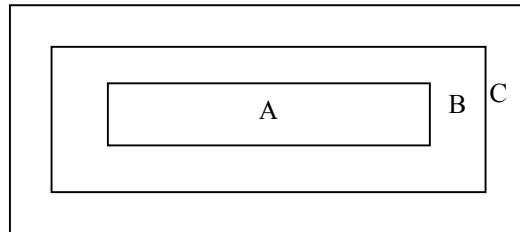

Zone A: Active Area

Zone B: Viewing Area except Zone A

Zone C: Outside Viewing Area

Note: As a general rule, visual defects in Zone C are permissible, when it is no trouble of quality and assembly to customer`s product.

◆ Inspection Methods

- 1 The general inspection : under 20W x 2 or 40W fluorescent light, about 30cm viewing distance, within 45° viewing angle, under 25±5°C.

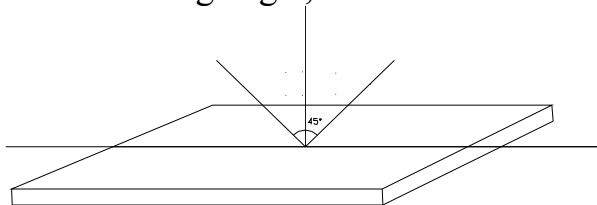

- 2 The luminance and color coordinate inspection : By PR705 or BM-7 or the equal equipments, in the dark room, under 25±5°C.

◆ Inspection Criteria

- 1 Major defect : AQL= 0.65

Item	Criterion
Function Defect	1. No display or abnormal display is not accepted
	2. Open or short is not accepted.
	3. Power consumption exceeding the spec is not accepted.
Outline Dimension	Outline dimension exceeding the spec is not accepted.
Glass Crack	Glass crack tends to enlarge is not accepted.

- 2 Minor Defect : AQL= 1.5

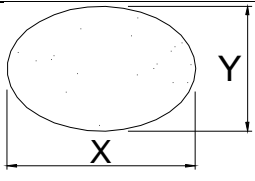
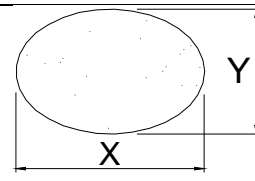
Item	Criterion			
Spot Defect (dimming and lighting spot)	Size (mm)		Accepted Qty	
			Area A + Area B	Area C
		$\Phi \leq 0.07$	Ignored	
		$0.07 < \Phi \leq 0.10$	3	Ignored
		$0.10 < \Phi \leq 0.15$	1	
$0.15 < \Phi$		0		
Note : $\Phi = (x + y) / 2$				
Line Defect (dimming and lighting line)	L (Length) : mm	W (Width) : mm	Area A + Area B	Area C
	/	$W \leq 0.02$	Ignored	
	$L \leq 3.0$	$0.02 < W \leq 0.03$	2	Ignored
	$L \leq 2.0$	$0.03 < W \leq 0.05$	1	
	/	$0.05 < W$	As spot defect	
Remarks: The total of spot defect and line defect shall not exceed 4 pcs. The distance between two lines defects must exceed 1 mm				
Polarizer Stain	Stain which can be wiped off lightly with a soft cloth or similar cleaning is accepted, otherwise, according to the Spot Defect and the Line Defect.			
Polarizer Scratch	1. If scratch can be seen during operation, according to the criterions of the Spot Defect and the Line Defect.			
	2. If scratch can be seen only under non-operation or some special angle, the criterion is as below :			
	L (Length) : mm	W (Width) : mm	Area A + Area B	Area C
	/	$W \leq 0.02$	Ignore	
	$3.0 < L \leq 5.0$	$0.02 < W \leq 0.04$	2	Ignore
	$L \leq 3.0$	$0.04 < W \leq 0.06$	1	
/	$0.06 < W$	0		
Polarizer Air Bubble	Size		Area A + Area B	Area C
		$\Phi \leq 0.20$	Ignored	
		$0.20 < \Phi \leq 0.30$	2	Ignored
		$0.30 < \Phi \leq 0.50$	1	
		$0.50 < \Phi$	0	

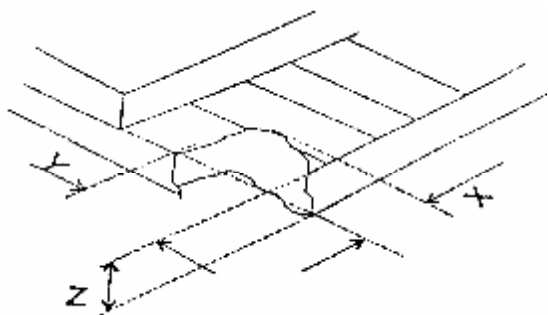
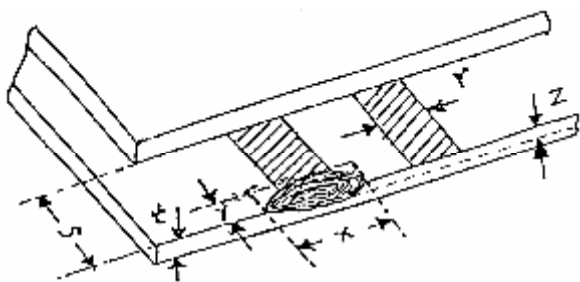
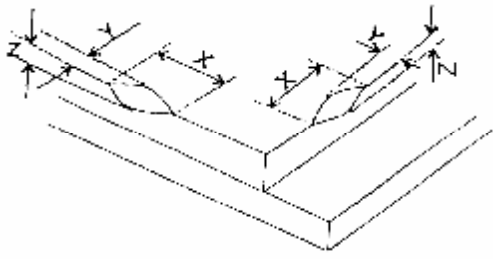
Glass Defect (Glass Chipped)	1. On the corner	(mm)	<table border="1"> <tr> <td>x</td> <td>≤ 1.5</td> </tr> <tr> <td>y</td> <td>≤ 1.5</td> </tr> <tr> <td>z</td> <td>$\leq t$</td> </tr> </table>	x	≤ 1.5	y	≤ 1.5	z	$\leq t$
	x	≤ 1.5							
	y	≤ 1.5							
	z	$\leq t$							
									
2. On the bonding edge	(mm)	<table border="1"> <tr> <td>x</td> <td>$\leq a / 4$</td> </tr> <tr> <td>y</td> <td>$\leq s / 3 \ \&\leq 0.7$</td> </tr> <tr> <td>z</td> <td>$\leq t$</td> </tr> </table>	x	$\leq a / 4$	y	$\leq s / 3 \ \&\leq 0.7$	z	$\leq t$	
x	$\leq a / 4$								
y	$\leq s / 3 \ \&\leq 0.7$								
z	$\leq t$								
									
	3. On the other edges	(mm)	<table border="1"> <tr> <td>x</td> <td>$\leq a / 8$</td> </tr> <tr> <td>y</td> <td>≤ 0.7</td> </tr> <tr> <td>z</td> <td>$\leq t$</td> </tr> </table>	x	$\leq a / 8$	y	≤ 0.7	z	$\leq t$
x	$\leq a / 8$								
y	≤ 0.7								
z	$\leq t$								
									
	Note: t: glass thickness ; s: pad width ; a: the length of the edge								
TCP Defect	Crack, deep fold and deep pressure mark on the TCP are not accepted								
Pixel Size	The tolerance of display pixel dimension should be within $\pm 20\%$ of the spec								
Luminance	Refer to the spec or the reference sample								
Color	Refer to the spec or the reference sample								

■ CAUTIONS IN USING OLED MODULE**◆ Precautions For Handling OLED Module:**

1. OLED module consists of glass and polarizer. Pay attention to the following items when handling:
 - i. Avoid drop from high, avoid excessive impact and pressure.
 - ii. Do not touch, push or rub the exposed polarizers with anything harder than an HB pencil lead.
 - iii. If the surface becomes dirty, breathe on the surface and gently wipe it off with a soft dry cloth. If it is terrible dirty, moisten the soft cloth with Isopropyl alcohol or Ethyl alcohol. Other solvents may damage the polarizer. Especially water, Ketone and Aromatic solvents.
 - iv. Wipe off saliva or water drops immediately, contact the polarizer with water over a long period of time may cause deformation.
 - v. Please keep the temperature within specified range for use and storage. Polarization degradation, bubble generation or polarizer peeling-off may occur with high temperature and high humidity.
 - vi. Condensation on the surface and the terminals due to cold or anything will damage, stain or dirty the polarizer, so make it clean as the way of iii.
2. Do not attempt to disassemble or process the OLED Module.
3. Make sure the TCP or the FPC of the Module is free of twisting, warping and distortion, do not pull or bend them forcefully, especially the soldering pins. On the other side, the SLIT part of the TCP is made to bend in the necessary case.
4. When assembling the module into other equipment, give the glass enough space to avoid excessive pressure on the glass, especially the glass cover which is much more fragile.
5. Be sure to keep the air pressure under 120 kPa, otherwise the glass cover is to be cracked.
6. Be careful to prevent damage by static electricity:
 - i. Be sure to ground the body when handling the OLED Modules.
 - ii. All machines and tools required for assembling, such as soldering irons, must be properly grounded.
 - iii. Do not assemble and do no other work under dry conditions to reduce the amount of static electricity generated. A relative humidity of 50%-60% is recommended.
 - iv. Peel off the protective film slowly to avoid the amount of static electricity generated.
 - v. Avoid to touch the circuit, the soldering pins and the IC on the Module by the body.
 - vi. Be sure to use anti-static package.
7. Contamination on terminals can cause an electrochemical reaction and corrode the terminal circuit, so make it clean anytime.
8. All terminals should be open, do not attach any conductor or semiconductor on the terminals.
9. When the logic circuit power is off, do not apply the input signals.
10. Power on sequence: $V_{DD} \rightarrow V_{CC}$, and power off sequence: $V_{CC} \rightarrow V_{DD}$.
11. Be sure to keep temperature, humidity and voltage within the ranges of the spec, otherwise shorten Module's life time, even make it damaged.
12. Be sure to drive the OLED Module following the Specification and datasheet of IC controller, otherwise something wrong may be seen.

13. When displaying images, keep them rolling, and avoid one fixed image displaying more than 30 seconds, otherwise the residue image is to be seen. This is the speciality of OLED.

◆ **Precautions For Soldering OLED Module:**

1. Soldering temperature : $260^{\circ}\text{C} \pm 10^{\circ}\text{C}$.
2. Soldering time : 3-4 sec.
3. Repeating time : no more than 3 times.
4. If soldering flux is used, be sure to remove any remaining flux after finishing soldering operation. (This does not apply in the case of a non-halogen type of flux.) It is recommended to protect the surface with a cover during soldering to prevent any damage due to flux spatters.

◆ **Precautions For Storing OLED Module:**

1. Be sure to store the OLED Module in the vacuum bag with dessicant.
2. If the Module can not be used up in 1 month after the bag being opened, make sure to seal the Module in the vacuum bag with dessicant again.
3. Store the Module in a dark place, do not expose to sunlight or fluorescent light.
4. The polarizer surface should not touch any other objects. It is recommended to store the Module in the shipping container.
5. It is recommended to keep the temperature between 0°C and 30°C , the relative humidity not over 60%.

◆ **Limited Warranty**

Unless relevant quality agreements signed with customer and law enforcement, for a period of 12 months from date of production, all products (except automotive products) TRULY will replace or repair any of its OLED modules which are found to be functional defect when inspected in accordance with TRULY OLED acceptance standards (copies available upon request). Cosmetic/visual defects must be returned to TRULY within 90 days of shipment. Confirmation of such date should be based on freight documents. The warranty liability of TRULY is limited to repair and/or replacement on the terms above. TRULY will not be responsible for any subsequent or consequential events.

◆ **Return OLED Module Under Warranty:**

1. No warranty in the case that the precautions are disregarded.
2. Module repairs will be invoiced to the customer upon mutual agreement. Modules must be returned with sufficient description of the failures or defects.

◆ **PRIOR CONSULT MATTER**

1. For TRULY standard products , we keep the right to change material ,process ... for improving the product property without any notice on our customer.
2. If you have special requirement about reliability condition, please let us know before you start the test on our samples.